

WORKSHOP MANUAL

Porsche

K-Jetronic

ROBERT BOSCH

CONTENTS

Introduction	3
Test Equipment	4
Component Location	5
Vacuum Diagram	9
Trouble-Shooting Chart	10
Vacuum Leaks	11
Component Tests	
Air Flow Sensor	12
Auxiliary Air Valve	16
Fuel Pump	17
Cold Start System	18
Warm-Up Regulator	19
System Pressure	22
Leakage Test	23
Testing Injectors	23
Comparative Test	24
Idle Speed and CO Adjustment	26
Mounting Pressure Tester	30
Component Repair	
Fuel Distributor Repair (911, 914)	32
Fuel Distributor Repair (928)	33
Fuel Pump Repair	34
Pressure Regulator Repair	35
Warm-up Regulator Repair (911)	35
Injector Removal (928)	36
Throttle Activated Valve	36
Electric Wiring Diagram	37
Parts List	39
Test Sheet	40

INTRODUCTION

Testing Procedures. The construction and operation of the K-Jetronic (CIS) fuel injection system is different from other fuel injection systems. The technical instruction booklet *Fuel Injection - Continuous Injection System (CIS)* at the back of the manual describes the components and operation of the K-Jetronic fuel injection system in detail. A thorough understanding of the various components is required before working on K-Jetronic fuel systems.

Before trouble-shooting, testing or adjusting the K-Jetronic fuel injection system, the ignition system and the mechanical system of the engine (compression, valve timing, etc.) must be within specification and operating properly. Verify that these systems are in proper working order before proceeding further.

K-Jetronic fuel systems have an electric safety circuit which prevents the electric fuel pump and other electrical devices from operating unless the engine is running or being started. The electric safety circuit can be bridged to apply voltage to any electrical component without running or starting the engine. This procedure can be found in the *Electric Wiring Diagram* section of the manual.

In addition, 911SC models use a thermo-valve, which enriches the fuel mixture during starting by blocking the warm-up regulator vacuum which decreases control pressure. After starting, the valve opens by means of an electric heating element.

Several component tests (*Auxiliary Air Valve* and *Warm-up Regulator*) require that the engine is cold. For cold tests, the engine must not have been run for several hours, preferably overnight.

Most vehicles since 1978 have fuel distributors which use **push valves** in the system pressure regulator to maintain pressure. Several component tests require special testing procedures for fuel distributors with push valves. The *Fuel Pump* section describes in detail how to identify a fuel distributor with a push valve in the system pressure regulator.

Thoroughly clean the fuel fittings before removing any fuel lines. Dirt must not enter the fuel system under any circumstances. Do NOT bend the steel fuel lines. When removing fuel lines, always hold the hex fitting on the component with one wrench while loosening the fuel line with another wrench. Do not bend the steel type fuel lines.

Always use new gaskets, seals and O-rings when installing components or fuel lines.

When installing the mixture control unit, tighten the fastening screws uniformly.

Whenever work is performed on the fuel injection system, the idle and CO must be adjusted.

How to use this manual. Use the trouble-shooting chart to find the cause(s) for a given symptom. The cause column will indicate what component(s) should be tested. Each component test instruction is a complete instruction. One component may be checked by following the test instructions for the specific component, or the entire system can be checked by following all the component instructions in order.

The *Tool List* and *Component Location* sections will help identify the necessary tools and help locate vehicle components to be tested. Specific component removal and installation information can be found in *Mounting the Pressure Tester* and *Component Repair*. The *Electric Wiring Diagram* section shows how to bridge the electric safety circuit to apply voltage to electrical components without running the engine. Replacement parts lists and complete test specifications can be found at the end of the workshop manual.

TEST EQUIPMENT

TOOL	PART NUMBER	APPLICATION
Pressure Tester	KDEP 1034	tests all working pressures
Connecting Parts	KDEP 1034/10 KDEP 1034/10/3 KDEP 1034/11	pressure tester fuel line adapters for various engines
Wrench	KDEP 1035 manufacturer tool	adjusts idle mixture (CO) all except 928 adjusts idle mixture (CO) for 928
Guide Rings	KDEP 1040/10 KDEP 1040/14	for 80 mm diameter sensor plates for 110 mm diameter sensor plates
Comparative Tester	KDJE 7451	tests injectors and fuel distributor for equal delivery
Accessory Set	KDJE 7451/25	for use with KDJE 7451 when engine is fitted with steel fuel lines
Valve Tester	KDJE 7452	tests injectors
1500 cc Graduate	commercially available	measures fuel pump delivery
Tachometer	commercially available	measures engine speed for idle and CO adjustment
CO meter	commercially available	measures CO for fuel mixture adjust- ment
Vacuum Pump	commercially available	for testing full load enriched warm- up regulators

COMPONENT LOCATION

911T, 911, 911S

through model 1975

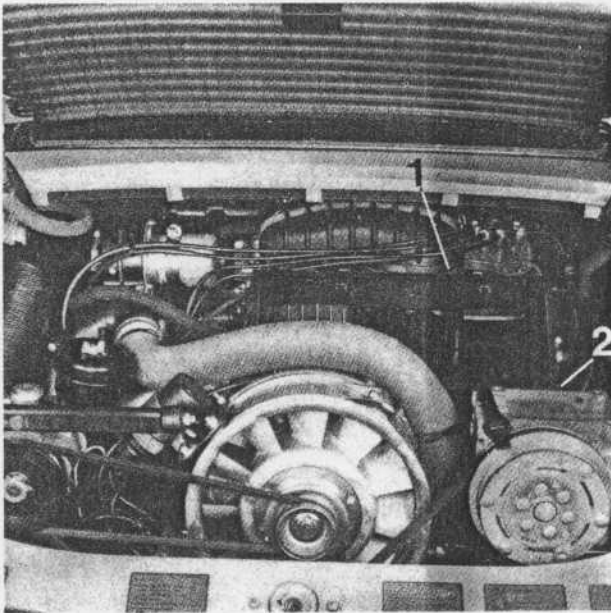

Mixture Control Unit (1), Injectors (2). The Start Valve is located on back of intake manifold below the venturi assembly. The Thermo-time Switch is located on engine block below the secondary air pump.

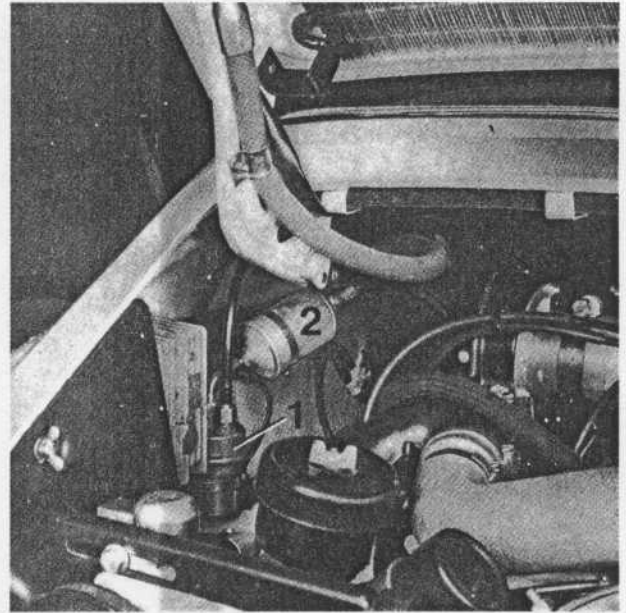

Fuel Accumulator (1), Fuel Filter (2)

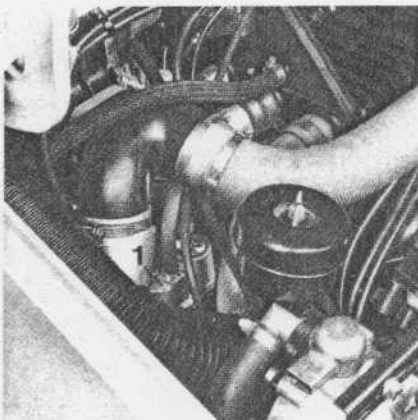

Warm-up Regulator (1)

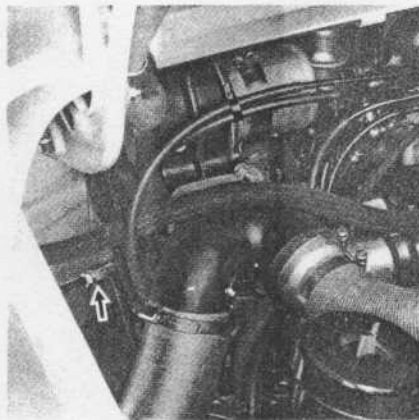

Fuel Pump Test Point (arrow)

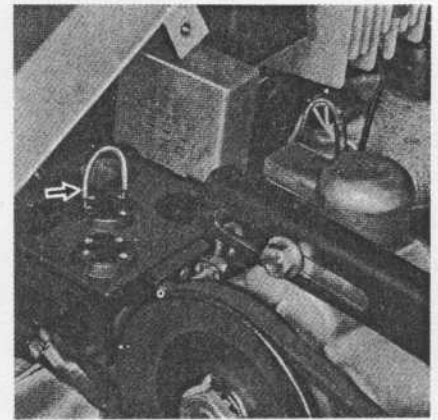

Bridging Electric Safety Circuit



Electric Fuel Pump

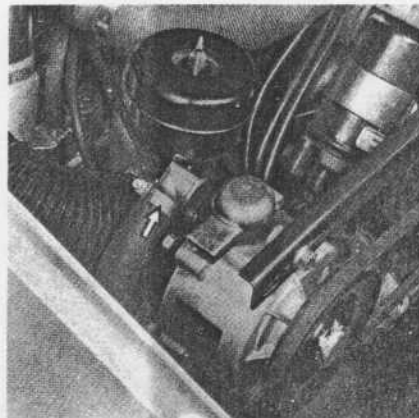

Secondary Air Pump Pressure Hose (arrow)

COMPONENT LOCATION

911, 911S, 911SC

beginning model 1976

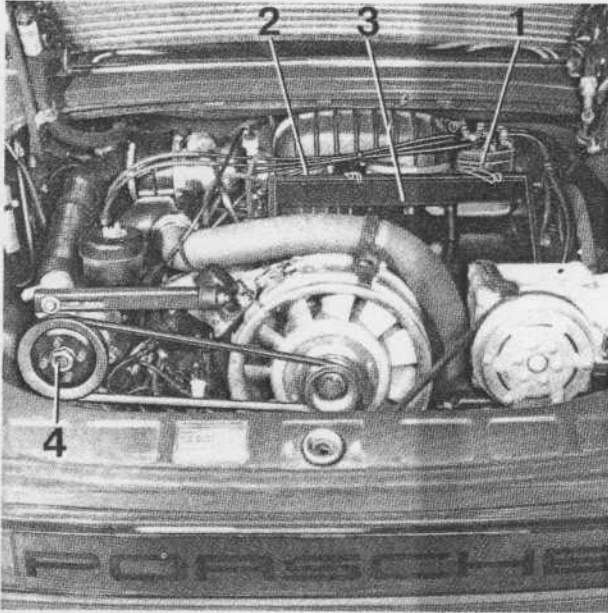

Mixture Control Unit with Air Filter Removed (1), Throttle Valve Assembly (2), Intake Housing (3), Secondary Air Pump (4)

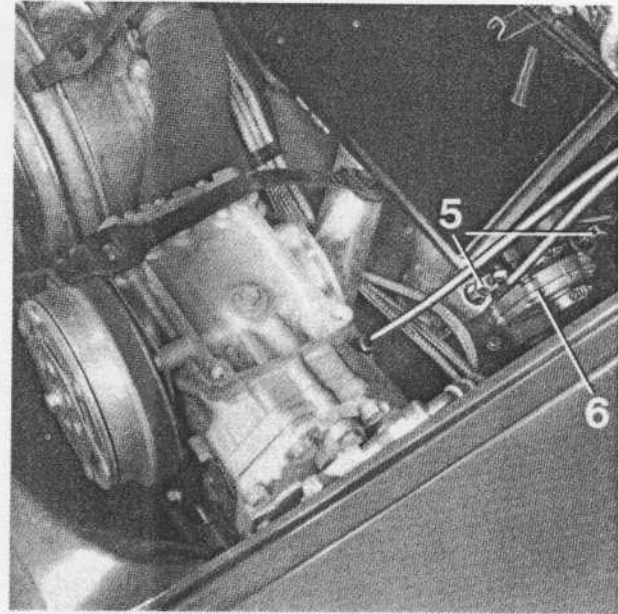

Injectors (5), Auxiliary Air Valve (6)

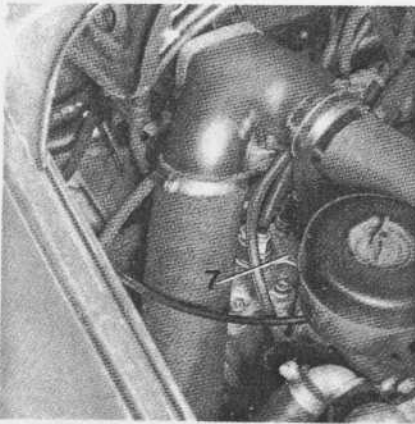

Warm-up Regulator (7)



Fuel Filter (8), Fuel Accumulator (9)

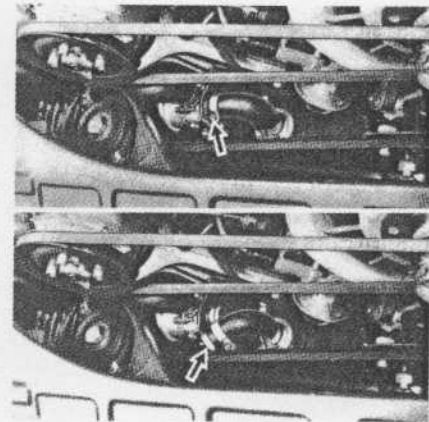

Secondary Air Pump Pressure Hose (arrow)

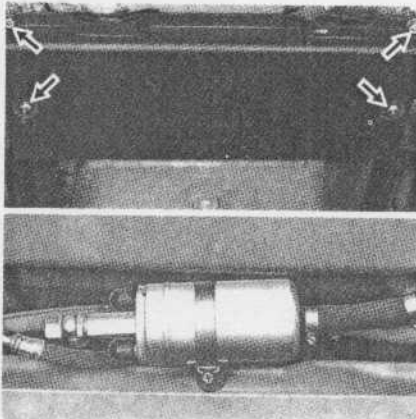

Fuel Pump Protective Cover (above), Fuel Pump (below)

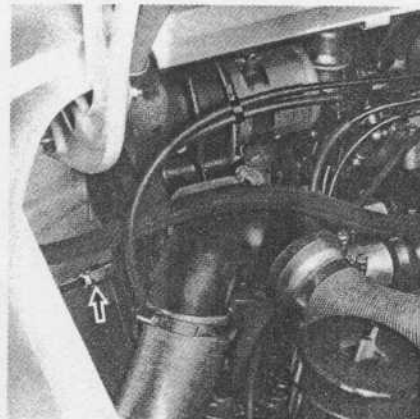

Fuel Pump Test Point (arrow)

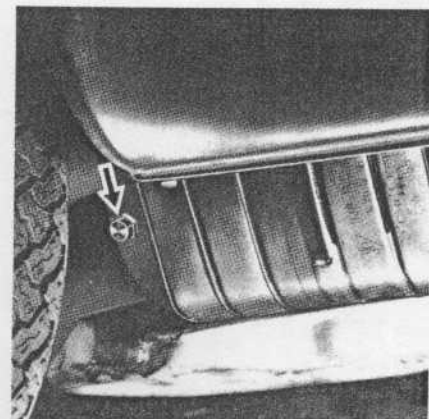

CO Test Point for Vehicles with Catalytic Converter

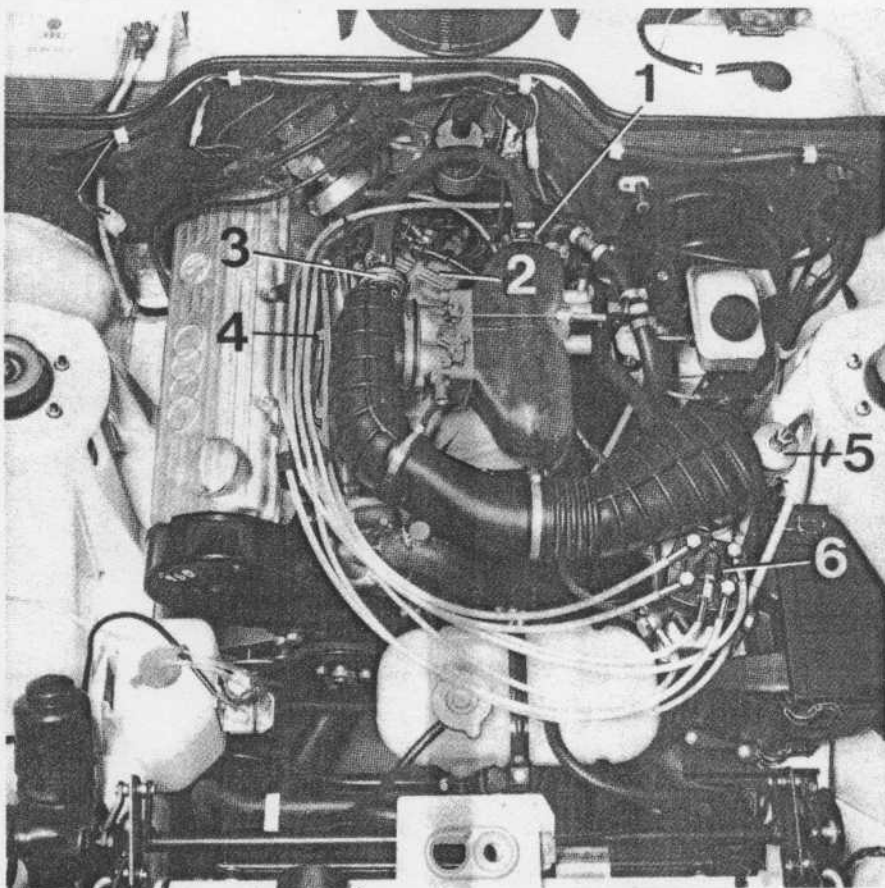

- 1 = Start Valve (hidden)
- 2 = Warm-up Regulator
- 3 = Auxiliary Air Valve
- 4 = Injectors
- 5 = Fuel Filter
- 6 = Mixture Control Unit

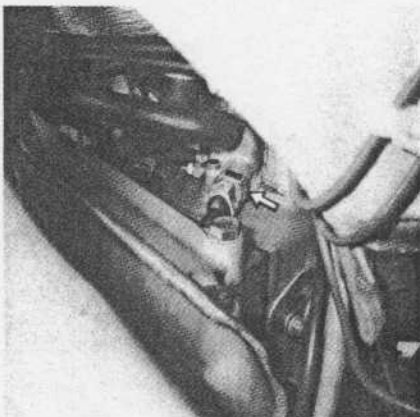

Thermo-time Switch (arrow) as viewed from underneath engine

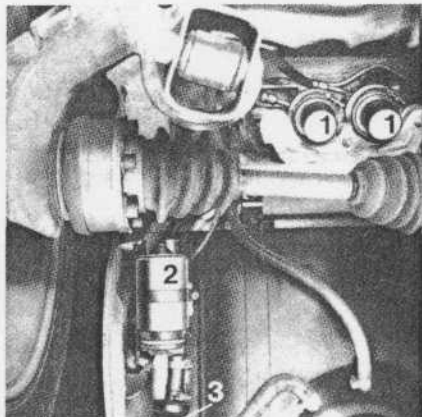

Fuel Accumulators (1), Fuel Pump (2), Noise Dampers (3) - since 1977

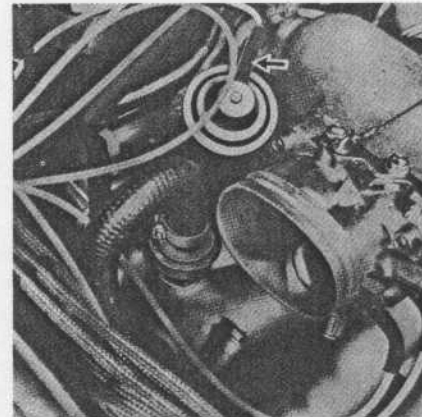

Exhaust Gas Recirculation Valve - Vacuum Hose (arrow)

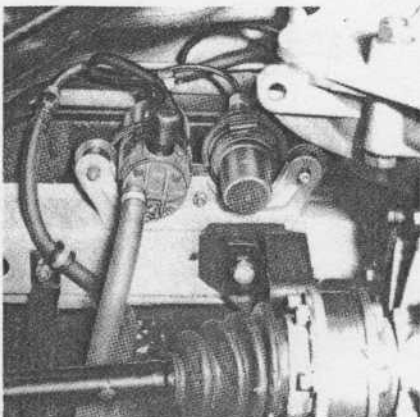

Fuel Pump and Fuel Accumulator - 1976 model

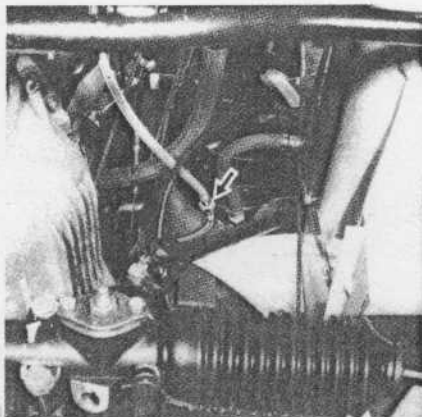

Fuel Pump Test Point (arrow)

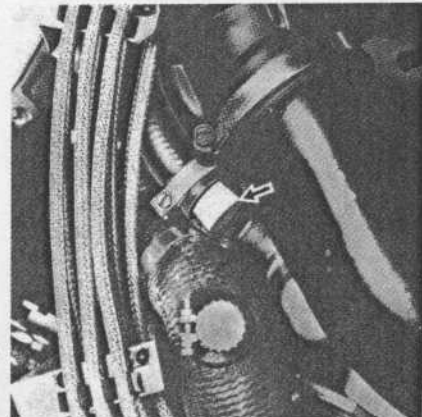

Secondary Air Pump Pressure Hose (arrow)

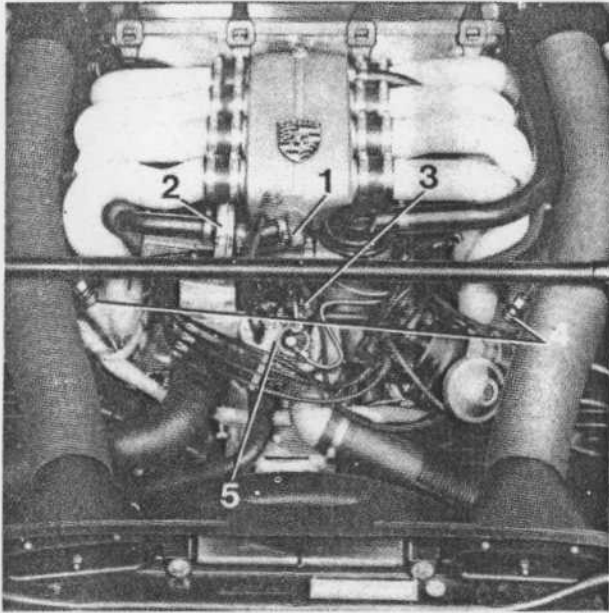

Start Valve (1), Auxiliary Air Valve (2), Thermo-time Switch (3), Injector (4), Warm-up Regulator (5)

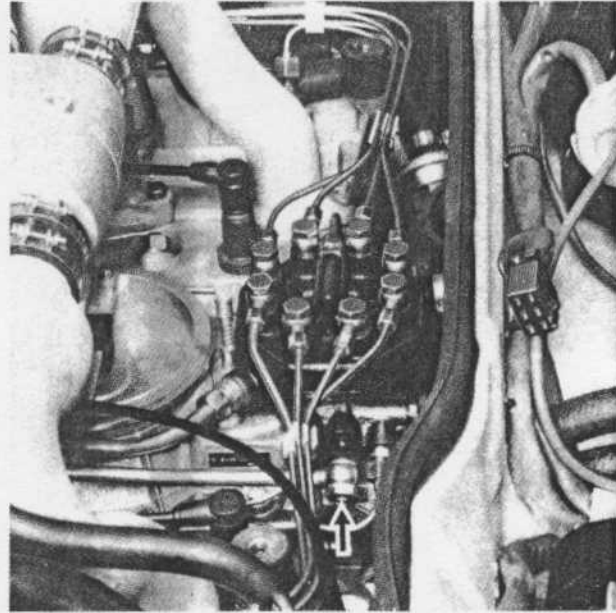

Mixture Control Unit

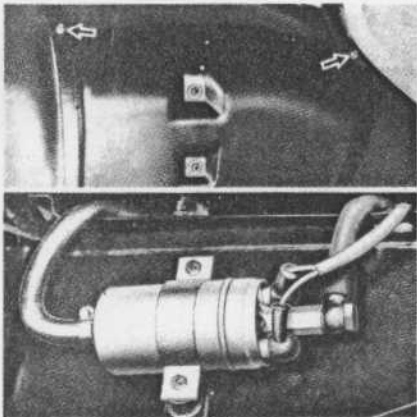

Fuel Pump Protective Cover (above), Fuel Pump No. 1 (below)

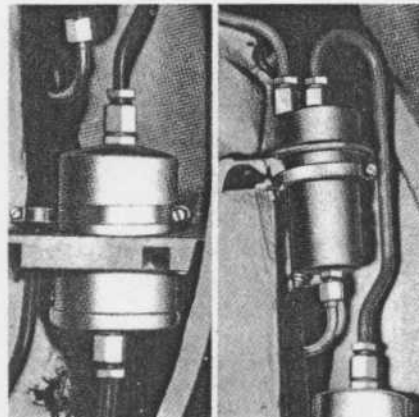

Fuel Accumulator and Fuel Filter - located in right rear wheel well

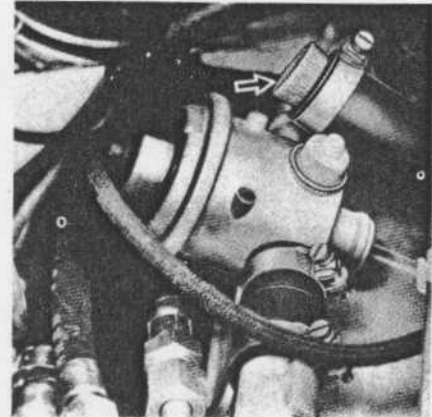

Secondary Air Pump Pressure Hose (arrow)

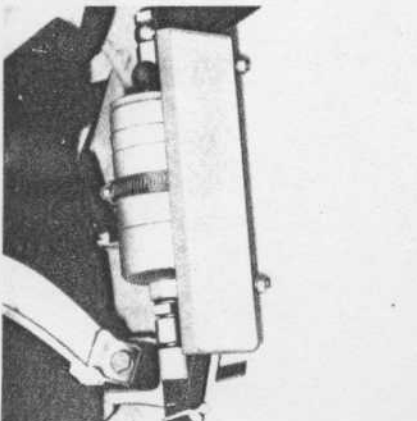

Fuel Pump No. 2 - located under right rear fender

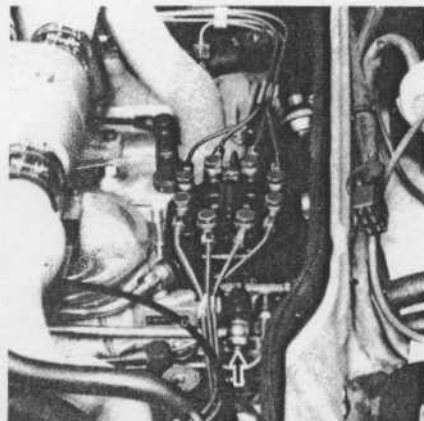

Fuel Pump Test Point (arrow)

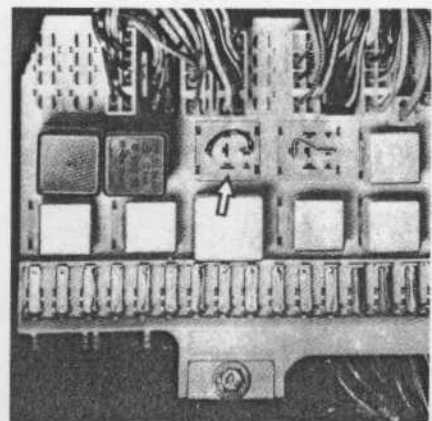

Bridging Electric Safety Circuit, relay No. XVII (arrow)

VACUUM DIAGRAM

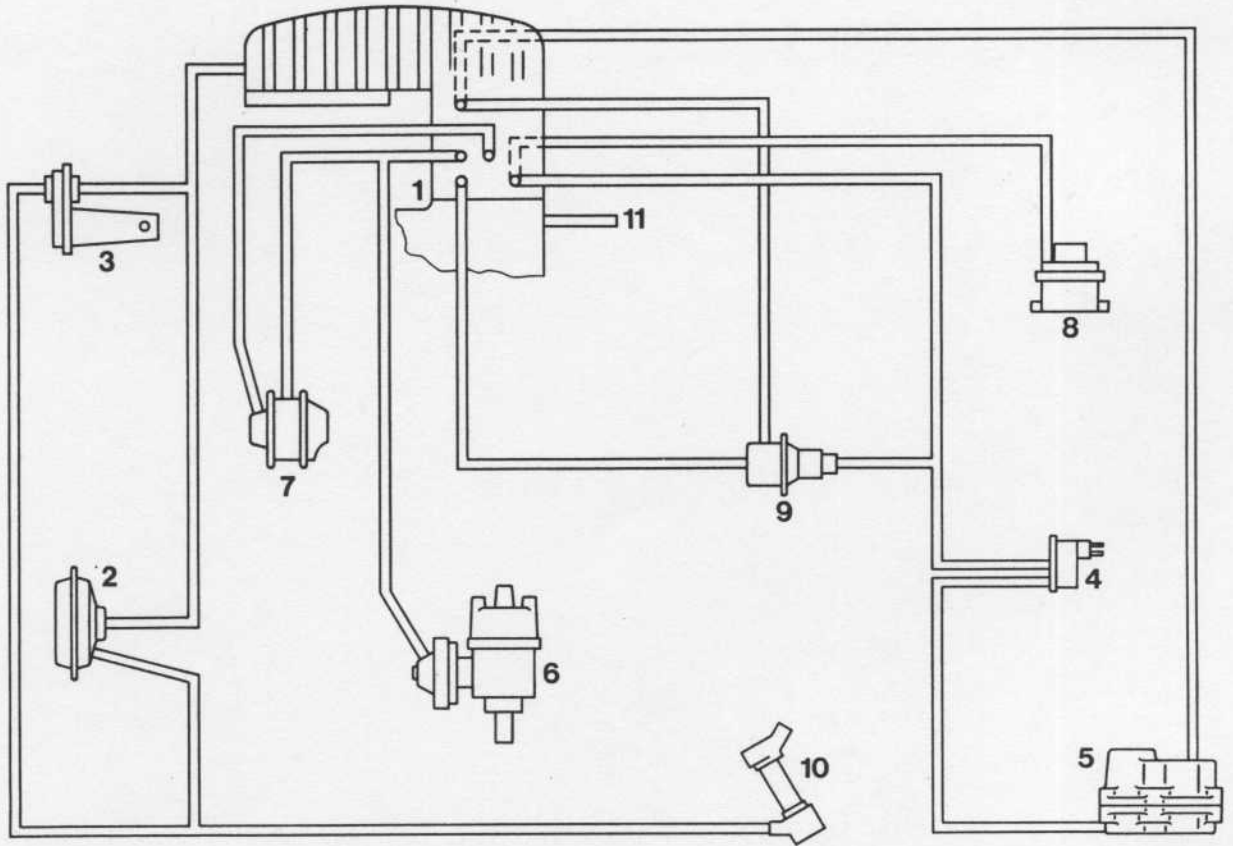

911 since 1976

- 1 = Throttle Valve Assembly
- 2 = Electro Air Valve
- 3 = Auxiliary Air Valve
- 4 = Thermo-valve (only 911 SC)
- 5 = Warm-up Regulator
- 6 = Ignition Distributor
- 7 = Exhaust Gas Recirculation Valve (only California)
- 8 = Changeover Dump Valve
- 9 = Vacuum Limiter
- 10 = Vacuum Takeoff for Auxiliary Air Valve and Auxiliary Air Device
- 11 = Vacuum Takeoff Power-assisted Brake System

TROUBLE-SHOOTING CHART

Symptoms														Cause(s)		
Engine does not start or starts poorly when cold	Engine does not start or starts poorly when warm	Irregular idle (engine shakes) during warm-up	Irregular idle (engine shakes) during warm-up	Engine does not draw fuel smoothly (backfires)	Insufficient power	Engine runs on (diesels)	Excessive fuel consumption	Flat spot during acceleration	Idle CO value too high	Idle CO value too low	Idle speed cannot be adjusted (too high)	Engine stalls immediately after starting			▶	Vacuum system leaking (see <i>Vacuum Leaks</i>)
															▶	Air flow sensor plate and/or control plunger not moving smoothly (see <i>Air Flow Sensor Movement</i>)
															▶	Air flow sensor plate stop incorrectly set (see <i>Air Flow Sensor Position</i>)
															▶	Auxiliary air valve does not open (see <i>Auxiliary Air Valve</i>)
															▶	Auxiliary air valve does not close (see <i>Auxiliary Air Valve</i>)
															▶	Electric fuel pump not operating (see <i>Fuel Pump</i>)
															▶	Defective cold start system (see <i>Cold Start System</i>)
															▶	Leaking cold start valve (see <i>Cold Start System</i>)
															▶	Incorrect cold control pressure (see <i>Warm-up Regulator</i>)
															▶	Warm control pressure too high (see <i>Warm-up Regulator</i>)
															▶	Warm control pressure too low (see <i>Warm-up Regulator</i>)
															▶	Incorrect system pressure (see <i>System Pressure</i>)
															▶	Fuel system pressure leakage (see <i>Fuel Leaks</i>)
															▶	Injection valve(s) leaking, opening pressure too low (see <i>Testing Injectors</i>)
															▶	Unequal fuel delivery between cylinders (see <i>Comparative Test</i>)
															▶	Basic idle and/or CO adjustment incorrect (see <i>Idle and CO Adjustment</i>)
															▶	Throttle plate does not open completely

VACUUM LEAKS

There must be no air leaks in the air intake system. Any air drawn into the engine without passing through the air flow sensor will cause a lean air-fuel mixture condition and improper engine operation.

To test for air leaks, remove the outlet hose from the auxiliary air valve and pressurize the hose with compressed air. Hold the throttle plate open and coat all air fittings (arrows below) with soapy water. Bubbles indicate a leak.

Replace any defective hoses, gaskets or seals.

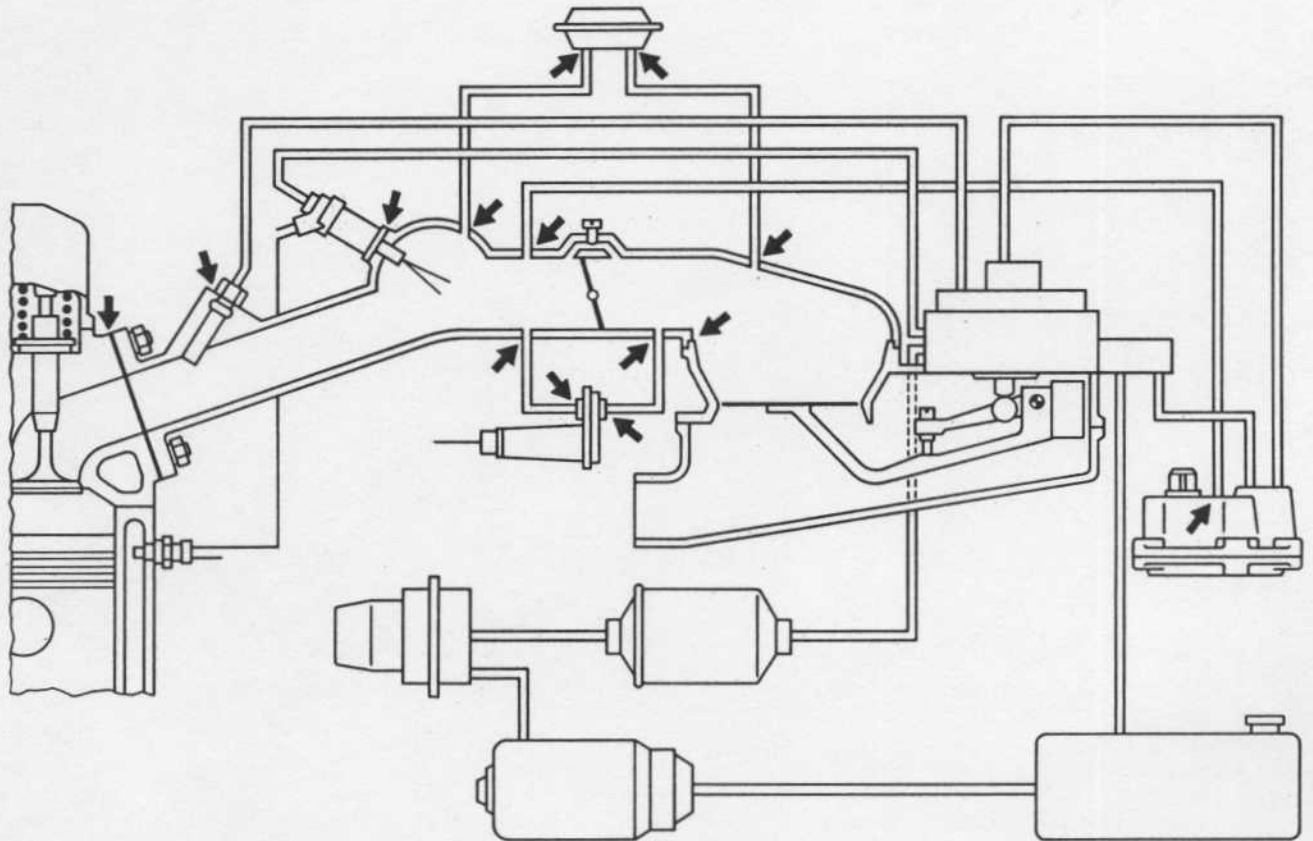

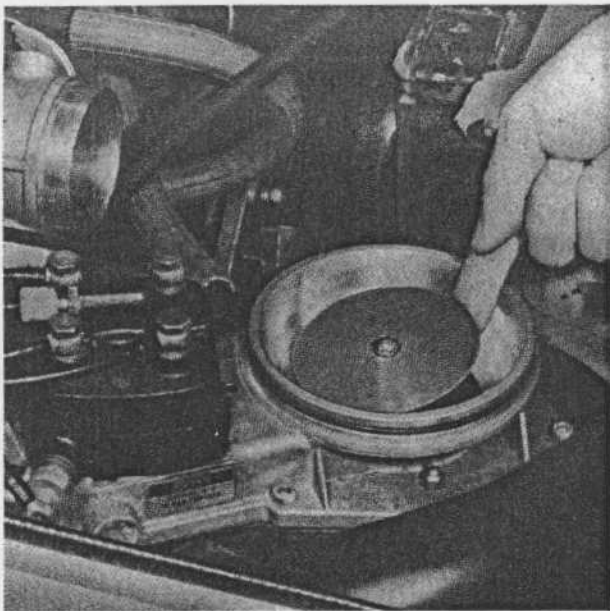

AIR FLOW SENSOR (updraft only)

Sensor Plate/Plunger Movement. Engine temperature must be above 20° C (68° F). Remove the rubber boot from the air flow sensor. Bridge the electric safety circuit (see *Electric Wiring Diagram*). Switch the ignition on for 10 seconds to apply control pressure to the plunger.

Fully lift the sensor plate up by hand to its maximum deflection as shown. Even resistance must be felt over the entire lever movement. If not, the air flow sensor plate is not moving freely, (see below).

Now push the sensor plate down rapidly, almost back to its rest position. The plunger will not follow the rapidly moving sensor plate, but the shock of the plunger hitting the sensor plate lever when it does come down must be felt. If this cannot be felt, the plunger is not moving freely, (see below).

Fully lift the air flow sensor plate up to its maximum deflection. When released, the sensor plate must fall back to its rest position after bouncing once or twice on the spring stop. If not, the air flow sensor plate is not moving freely, (see below).

If the **air flow sensor plate** does not move freely, loosen the mounting screws around the air flow sensor housing to check if housing warpage is causing the lever to bind. If necessary, replace the gasket under the air flow sensor and uniformly tighten the fastening screws.

If the **plunger** does not move freely, remove the fuel distributor from the air flow sensor (see *Fuel Distributor Repair*). Remove the plunger from the fuel distributor. If it is necessary to blow compressed air in the control pressure connection hole to free the plunger, hold the plunger with your hand as shown to prevent the plunger from falling out of the fuel distributor. Clean the plunger with an appropriate solvent. If the plunger still binds in its barrel, replace the fuel distributor.

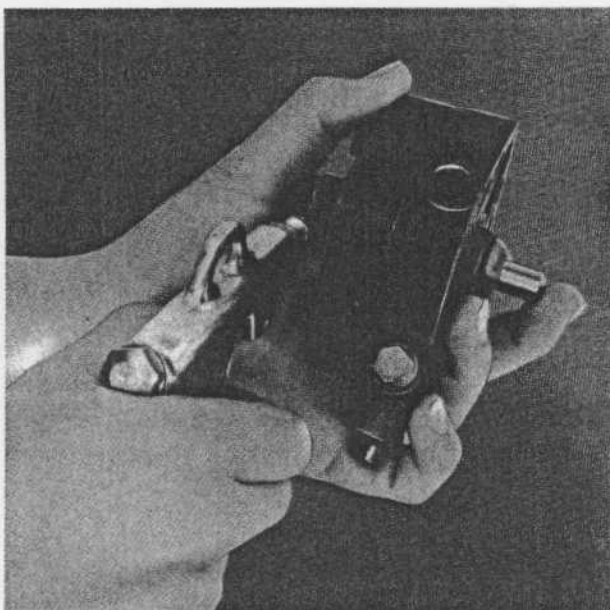

Air Flow Sensor Plate Position. Remove the rubber boot from the air flow sensor. The sensor plate must be flat and pass through the narrowest part of the funnel without touching the sides.

If the sensor plate touches the sides of the funnel, loosen the sensor plate fastening screw. Insert the appropriate guide ring (see *Tool List*). Hold the fastening screw with pliers to prevent the plate from moving down as shown. When the guide ring is in place, tighten the fastening screw to 5.0 - 5.5 Nm (3.7 - 4.0 ft lbs). Then, loosen the screw and retorque the fastening screw again to the same value. The air flow sensor plate must not now be able to be turned by hand.

Bridge the electric safety circuit (see *Electric Wiring Diagram*). Switch the ignition on for 10 seconds to apply control pressure to the plunger.

The upper edge of the sensor plate should be flush with the beginning of the upper cone as shown. The upper edge of the sensor plate may be as much as 0.5 mm below the beginning of the upper cone, but must NOT project up into the cone at all.

Adjust the sensor plate position by removing the air filter and bending the wire loop on the spring stop (arrow) or turning the adjusting screw (1). Tighten the lock nut before rechecking the sensor plate position.

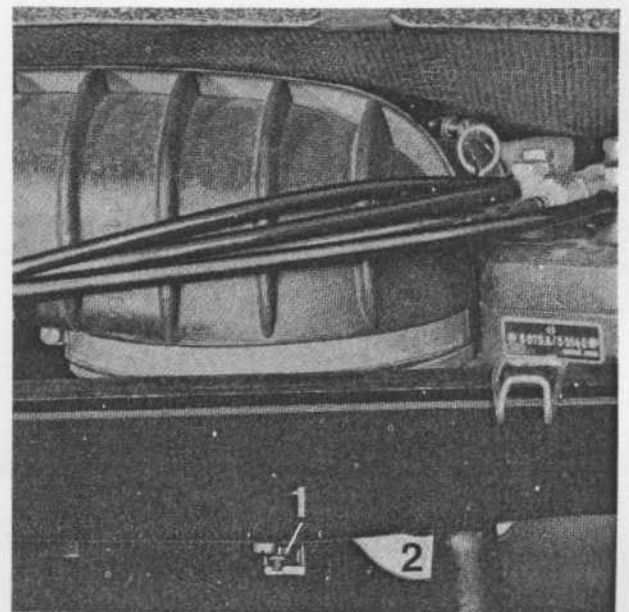
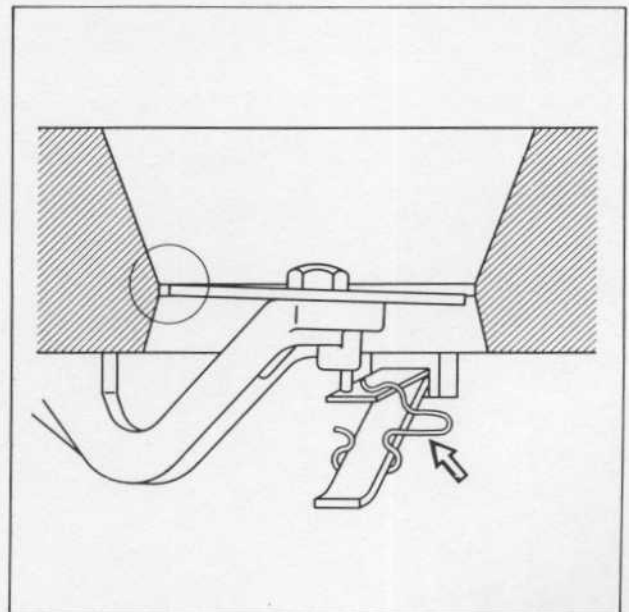
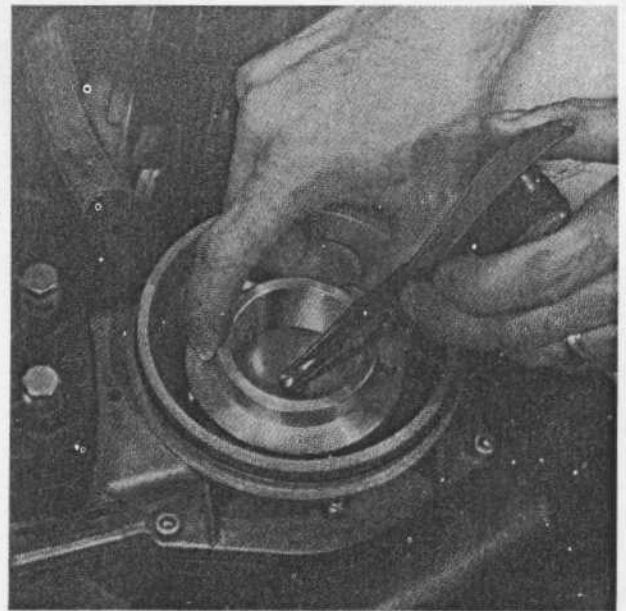

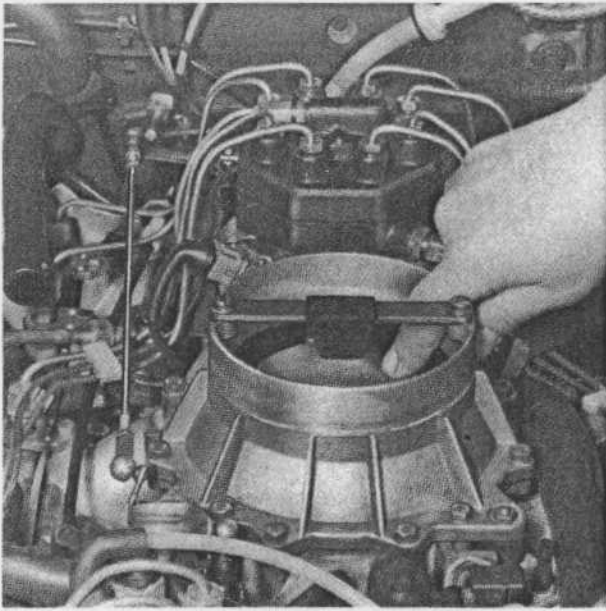

AIR FLOW SENSOR (downdraft only)

Sensor Plate/Plunger Movement. Engine temperature must be above 20° C (68° F). Remove the air filter from the air flow sensor. Bridge the electric safety circuit (see *Electric Wiring Diagram*). Switch the ignition on for 10 seconds to apply control pressure to the plunger.

Fully push the sensor plate down by hand to its maximum deflection as shown. Even resistance must be felt over the entire lever movement. If not, the air flow sensor plate is not moving freely, (see below).

Now pull the sensor plate up rapidly, almost back to its rest position. The plunger will not follow the rapidly moving sensor plate, but the shock of the plunger hitting the sensor plate lever when it does come down must be felt. If this cannot be felt, the plunger is not moving freely, (see below).

Fully push the air flow sensor plate down to its maximum deflection. When released, the sensor plate must fall back to its rest position after bouncing once or twice on the spring stop. If not, the air flow sensor plate is not moving freely, (see below).

If the **air flow sensor plate** does not move freely, loosen the mounting screws around the air flow sensor housing to check if housing warpage is causing the lever to bind. If necessary, replace the gasket under the air flow sensor and uniformly tighten the fastening screws.

If the **plunger** does not move freely, remove the fuel distributor from the air flow sensor (see *Fuel Distributor Repair*). Remove the plunger from the fuel distributor. If it is necessary to blow compressed air in the control pressure connection hole to free the plunger, hold the plunger with your hand as shown to prevent the plunger from falling out of the fuel distributor. Clean the plunger with an appropriate solvent. If the plunger still binds in its barrel, replace the fuel distributor.

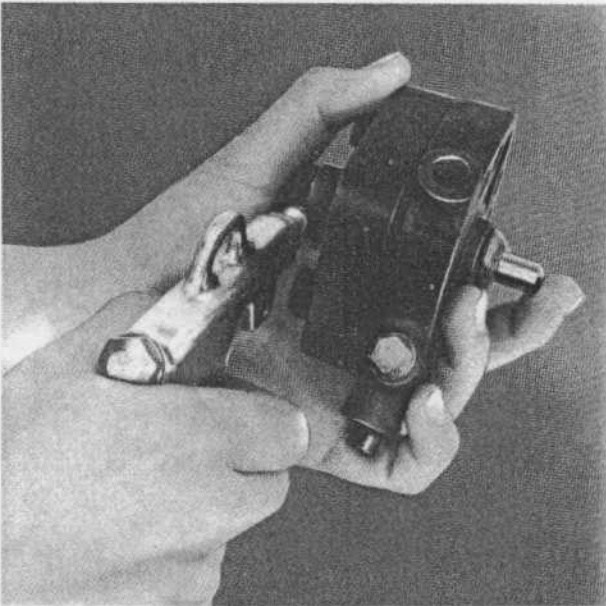

Air Flow Sensor Plate Position. Remove the air filter from the air flow sensor. The sensor plate must be flat. The chamfered edge of the sensor plate must face down. The word 'top' or five punch marks are stamped on the top of the sensor plate.

The sensor plate must pass through the narrowest part of the funnel without touching the sides. If the sensor plate touches the sides of the funnel, loosen the sensor plate fastening screw. Insert the appropriate guide ring (see *Tool List*). Hold the fastening screw as shown to prevent the sensor plate from moving down. When the guide ring is in place, tighten the fastening screw to 5.0 - 5.5 Nm (3.7 - 4.0 ft lbs). Then, loosen the screw and retorque to the same value. The air flow sensor plate must not now be able to be turned by hand.

Bridge the electric safety circuit (see *Electric Wiring Diagram*). Switch the ignition on for 10 seconds to apply control pressure to the plunger.

The upper edge of the sensor plate should be flush with the beginning of the upper cone as shown. The upper edge of the sensor plate may project up as much as 0.5 mm above the beginning of the upper cone, but the lower edge of the sensor plate (above the chamfer) must not project down into the lower cone at all.

If the sensor plate is too high, very carefully tap the guide pin (arrow) deeper into the housing. *Caution: Make this adjustment very carefully. Adjustment several times in both directions will loosen the press fit of the pin, possibly causing engine damage.*

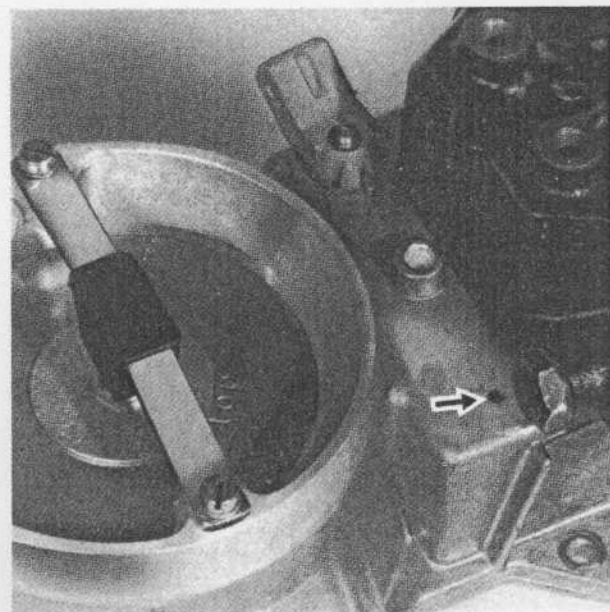
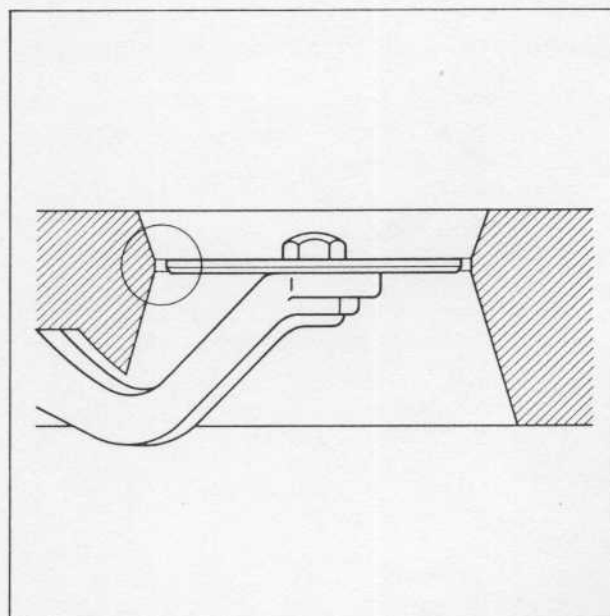
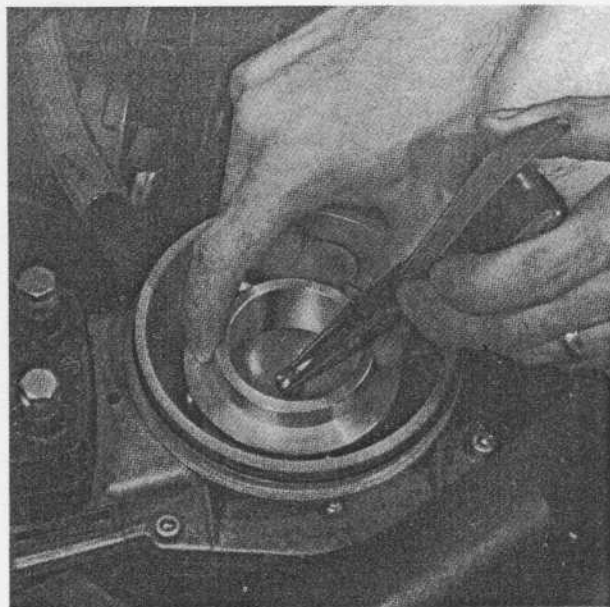

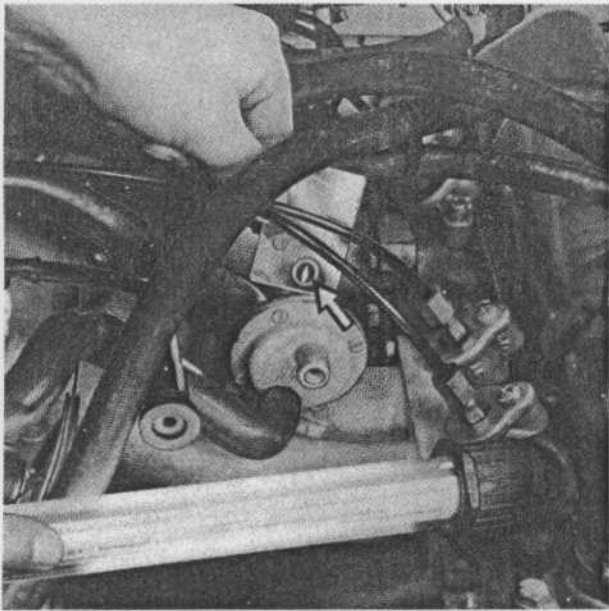

AUXILIARY AIR VALVE

Cold Operation. Test the auxiliary air valve first with the engine cold (not run for several hours, preferably overnight). Disconnect the electric plug from the auxiliary air valve and from the warm-up regulator. Remove both air hoses from the auxiliary air valve.

Using a flashlight and a mirror, look through the valve as shown. When the engine is cold, the valve must be open. If not, replace the auxiliary air valve.

Warm Operation. Attach the electric plug to the auxiliary air valve. Bridge the electric safety circuit (see *Electric Wiring Diagram*). Turn the ignition on. The auxiliary air valve must be completely closed within 10 minutes.

If the auxiliary air valve does not completely close within 10 minutes, test the supply voltage (approximately 11.5 volts, ignition off) available to the auxiliary air valve at the electric plug.

If sufficient voltage is available to the auxiliary air valve and the valve still does not close, replace the auxiliary air valve.

FUEL PUMP

The test point for fuel pump operation depends on the type of fuel distributor. Fuel distributors WITH push valves (most vehicles since 1978) have two fuel lines connecting with the warm-up regulator. Fuel distributors WITHOUT push valves have only one fuel line connecting directly to the warm-up regulator; the other fuel line connects to a "T" and returns to the gas tank. Determine whether the vehicle to be tested is fitted with or without a push valve before proceeding further.

Disconnect the return fuel line leading to the gas tank at the appropriate test point, as indicated below for the specific vehicle.

Test Point for 911: Disconnect the union fitting on the fuel return line from the fuel distributor (see *Component Location*). Connect a temporary hose with an appropriate fitting (M 14 x 1.5) to the line coming from the fuel distributor.

Test Point for 924: Clean and disconnect the union fitting located above the front axle (see *Component Location*).

Test Point for 928: Disconnect the fuel line from the fuel distributor which leads to the gas tank (see *Component Location*). Connect a temporary fuel line with an appropriate fitting (M 14 x 1.5) to the outlet on the fuel distributor.

Hold the line coming from the fuel distributor in a 1500 cc or larger graduate. Inflexible metal fuel lines may require a rubber hose to reach the graduate.

Remove the electric plug from the warm-up regulator and the auxiliary air valve. Bridge the electric safety circuit (see *Electric Wiring Diagram*).

Turn the ignition on for the amount of time specified for *Fuel Pump* on the test sheet.

If fuel quantity is not within specification, check for sufficient voltage supply to the fuel pump (minimum 11.5 volts) or a dirty fuel filter. If all the above are satisfactory, replace the electric fuel pump.

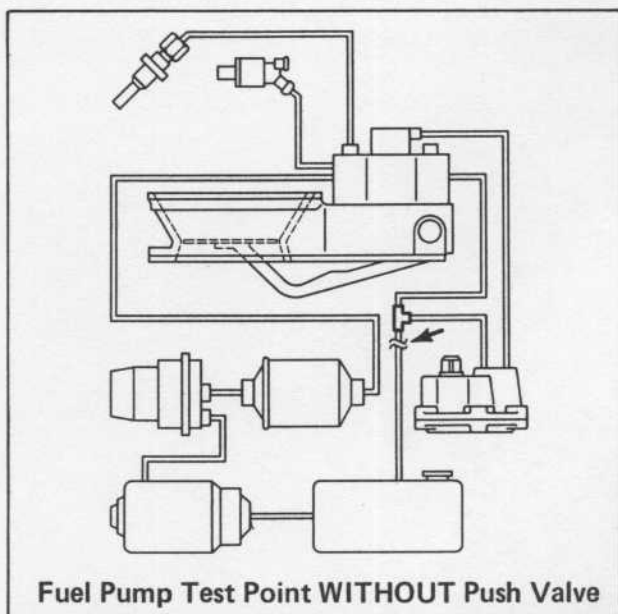
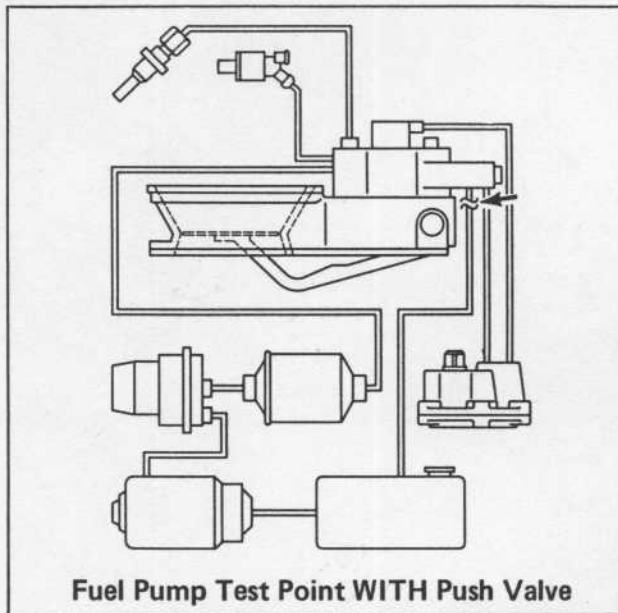

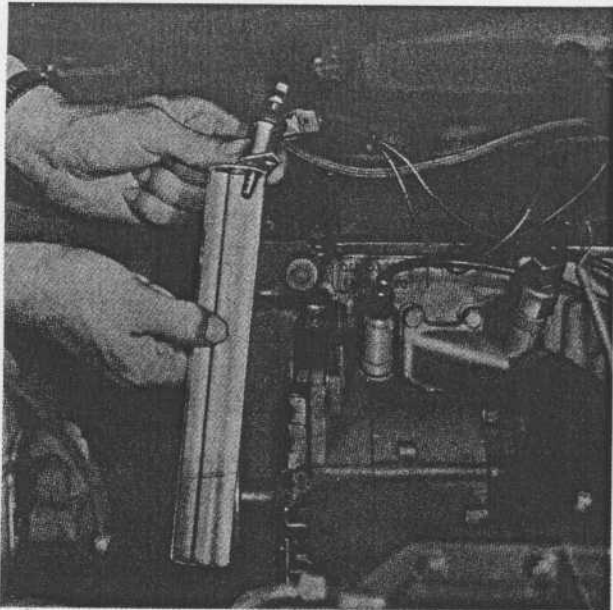

COLD START SYSTEM

Thermo-Time Switch. This instruction applies only to Robert Bosch thermo-time switches.

Remove the thermo-time switch from the engine. Engine coolant will spill out when the switch is removed from the engine. Find the design number stamped on the flats of the thermo-time switch housing. Use the design number to find the appropriate test values from the thermo-time switch chart below.

Using an ohmmeter, check the resistance at both temperatures indicated on the thermo-time switch chart. Use warm water to heat the switch as required.

If any resistance does not fall within the specified tolerance, replace the thermo-time switch.

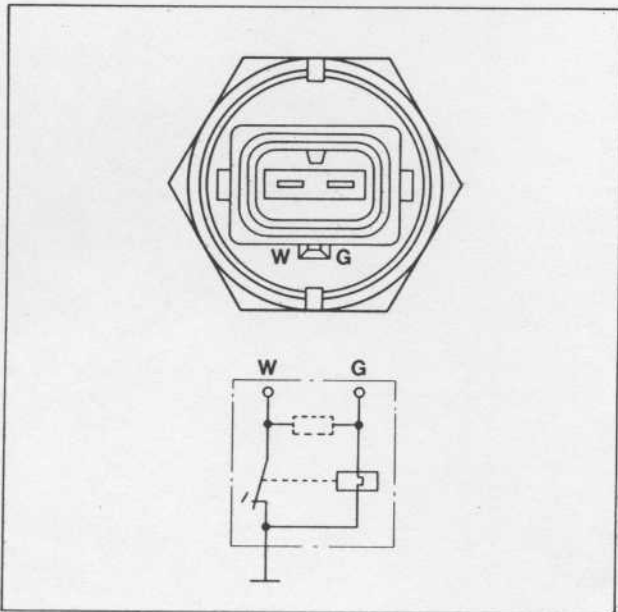

THERMO-TIME SWITCH CHART

Design Number	Temperature	Resistance in ohms		
		from terminal G to Ground	from terminal W to Ground	from terminal G to W
45° C/9.5 s	below 104° F	30 - 40	0	30 - 40
	above 122° F	55 - 85	120 - 160	55 - 85
35° C/8 s	below 86° F	25 - 40	0	25 - 40
	above 104° F	50 - 80	100 - 160	50 - 80
18° C/8 s	below 55° F	50 - 70	0	50 - 70
	above 73° F	50 - 70	infinite	50 - 70
15° C/8 s	below 50° F	50 - 70	0	infinite
	above 68° F	50 - 70	infinite	infinite

Cold Start Valve. Disconnect the electric plug from the cold start valve. Remove the cold start valve from the intake manifold. Hold the cold start valve in a graduate. A rubber hose may be required to reach the graduate.

Temporarily connect one start valve terminal to ground and the other terminal to the "+" terminal of the ignition coil. Bridge the electric safety circuit (see *Electric Wiring Diagram*). Turn the ignition on for not more than 30 seconds. If the cold start valve does not spray, replace the cold start valve. *Caution: Keep the cold start valve and connecting wires away from the "+" battery terminal to prevent sparking.*

Turn the ignition off and disconnect the temporary electrical wires from the cold start valve. Wipe the cold start valve dry. With the electric safety circuit still bridged, switch the ignition on for one minute. If the cold start valve drips or leaks, replace the cold start valve.

WARM-UP REGULATOR (CONTROL PRESSURE)

Porsche uses several warm-up regulators on its vehicles. The testing procedure and test specifications are different for each type of warm-up regulator. Find the warm-up regulator type to be tested from the ones listed below and proceed with the test instructions for that specific type.

Standard Warm-Up Regulator. Connect pressure tester KDEP 1034 (see *Mounting Pressure Tester*). Use the test specification for the specific warm-up regulator.

Cold Control Pressure: The engine must be cold (not run for several hours, preferably overnight). Disconnect the plug from the warm-up regulator. Open both valve screws on the three-way valve of the pressure tester. Bridge the safety circuit (see *Electric Wiring Diagram*).

Switch the ignition on to run the electric fuel pump and read the **cold control pressure** on the gauge. The pressure must be within the tolerance band given on the appropriate test specification graph. Turn the ignition off.

Warm Control Pressure: Engine temperature is not important. Attach the plug to the warm-up regulator. Bridge the safety circuit. Open both valve screws on the pressure tester as shown.

Switch the ignition on to operate the electric fuel pump. When the pressure stops increasing, read **warm control pressure** on the gauge. The warm control pressure must be within the tolerance given on the test sheet. Turn the ignition off.

If the warm control pressure does not fall within the specified tolerance, test the supply voltage (approximately 14 volts) available to the warm-up regulator.

If sufficient voltage is available to the warm-up regulator, and the warm control pressure still does not fall within the specified tolerance, replace the warm-up regulator.

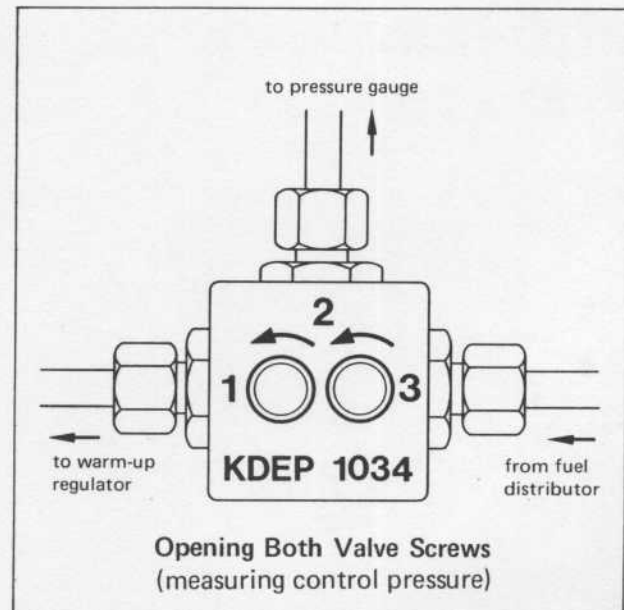
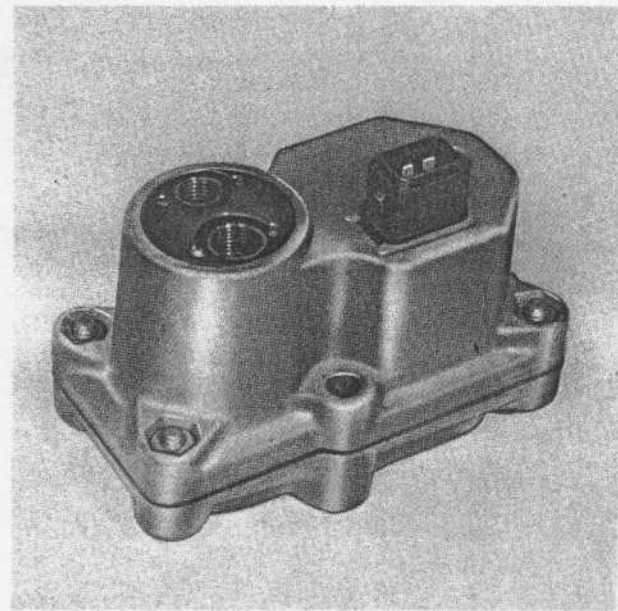

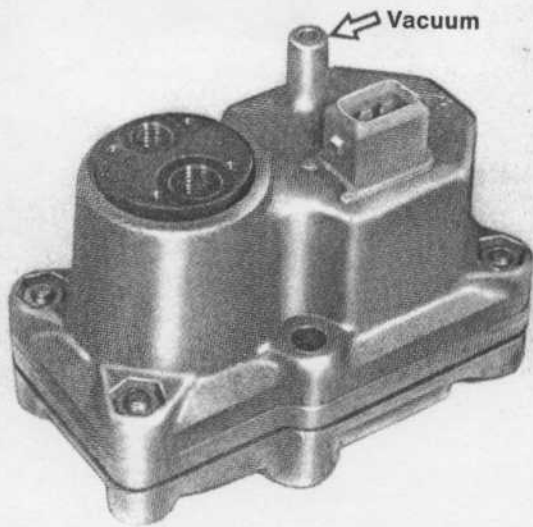

Warm-Up Regulator with Full Load Enrichment. Connect pressure tester KDEP 1034 (see *Mounting Pressure Tester*). Use the test specification for the specific warm-up regulator.

Cold Control Pressure: The engine must be cold (not run for several hours, preferably overnight) unless otherwise indicated on the test sheet. Disconnect the plug from the warm-up regulator. Open both valve screws on the three-way valve of the pressure tester. Bridge the safety circuit (see *Electric Wiring Diagram*).

Switch the ignition on to run the electric fuel pump. Apply the vacuum indicated on the test sheet (if any) to the warm-up regulator with a vacuum pump as shown. The cold control pressure indicated on the gauge must be within the tolerance band shown on the appropriate test specification graph. Turn the ignition off.

Warm Control Pressure: Test warm control pressure with the warm-up regulator plug attached. Engine temperature is not important. Bridge the safety circuit. Open both valve screws on the pressure tester as shown.

Switch the ignition on to run the electric fuel pump. Apply the vacuum indicated on the test sheet (if any) to the warm-up regulator with a vacuum pump as shown. When the pressure stops increasing, read the warm control pressure on the gauge. The warm control pressure must be within the tolerance given on the test sheet. Turn the ignition off.

Warm Control Pressure WITH Throttle Activated Valve: Test warm control pressure with the warm-up regulator plug attached. Position throttle plate against idle stop.

Switch the ignition on to run the electric fuel pump. When the pressure stops increasing, read the warm control pressure on the gauge. If the warm control pressure is not within the tolerance given for idle on the test sheet, remove both fastening screws on the throttle activated valve and turn the valve in the area of the slots. If the idle value cannot be obtained, replace the throttle activated valve and readjust to the value given for idle on the test sheet.

Position the throttle plate by hand about halfway. If the pressure does not rise to the partial load value given on the test sheet, replace the warm-up regulator.

Completely open the throttle to the full load position. If the pressure does not drop to the full load value given on the test sheet, replace the throttle activated valve and recheck the idle pressure.

If the warm control pressure does not fall within the specified tolerance, test the supply voltage (approximately 14 volts) available to the warm-up regulator.

If sufficient voltage is available to the warm-up regulator, and the warm control pressure still does not

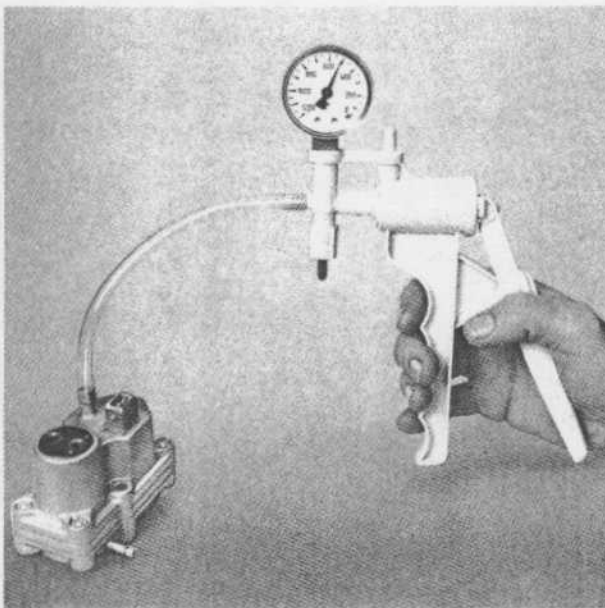
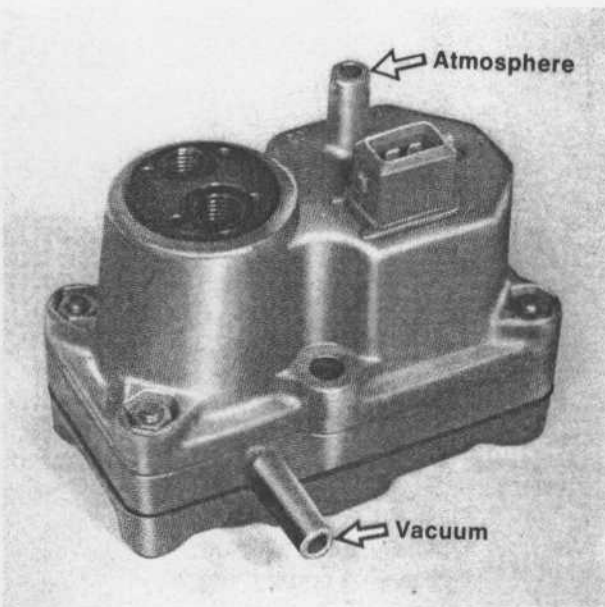

fall within the specified tolerance, check the vacuum source for a leak.

If warm control pressure cannot be brought into specification, replace the warm-up regulator.

Warm-Up Regulator with Full Load and Altitude Compensator. Connect pressure tester KDEP 1034 (see *Mounting Pressure Tester*). Use the test specification for the specific warm-up regulator.

Cold Control Pressure: The engine must be cold (not run for several hours, preferably overnight) unless otherwise indicated on the test sheet. Disconnect the plug from the warm-up regulator. Open both valve screws on the three-way valve of the pressure tester. Bridge the safety circuit (see *Electric Wiring Diagram*).

Switch the ignition on to run the electric fuel pump. Apply the vacuum indicated on the test sheet (if any) to the warm-up regulator with a vacuum pump as shown. The cold control pressure indicated on the gauge must be within the tolerance band shown on the appropriate test specification graph. Turn the ignition off.

Warm Control Pressure: Test warm control pressure with the warm-up regulator plug attached and the engine warm. Use station pressure from the local airport or weather bureau, NOT the corrected barometric pressure reported to the public, when reading the warm control pressure graph on the test sheet. Bridge the safety circuit. Open both valve screws on the pressure tester as shown.

Switch the ignition on to run the electric fuel pump. Apply the vacuum indicated on the test sheet (if any) to the warm-up regulator with a vacuum pump as shown. When the pressure stops increasing, read the warm control pressure on the gauge. The warm control pressure must be within the tolerance given on the test sheet (use upper curve when testing WITH vacuum). Turn ignition off.

If the warm control pressure does not fall within the specified tolerance, test the supply voltage (approximately 14 volts) available to the warm-up regulator.

If sufficient voltage is available to the warm-up regulator, and the warm control pressure still does not fall within the specified tolerance, check the vacuum source for a leak.

If the high control pressures required for high altitudes cannot be obtained, increase system pressure to the high side of the tolerance band (see *System Pressure*).

If warm control pressure cannot be brought into specification, replace the warm-up regulator.

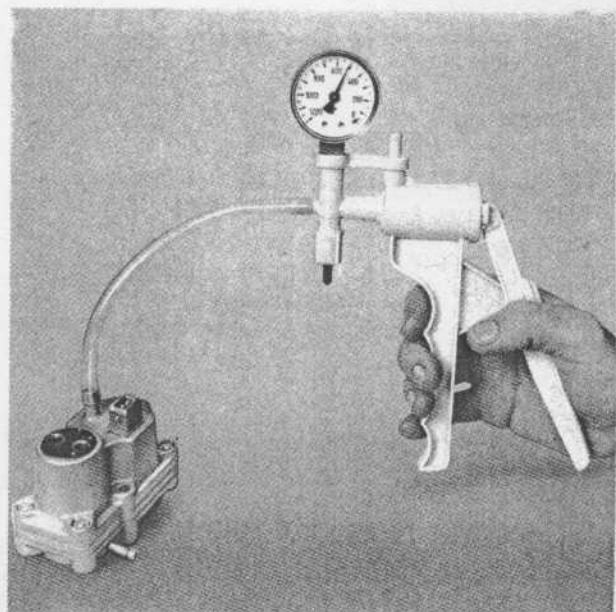
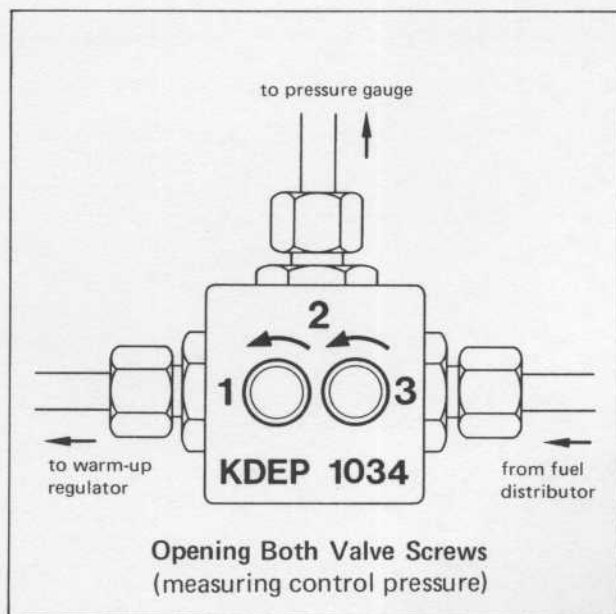
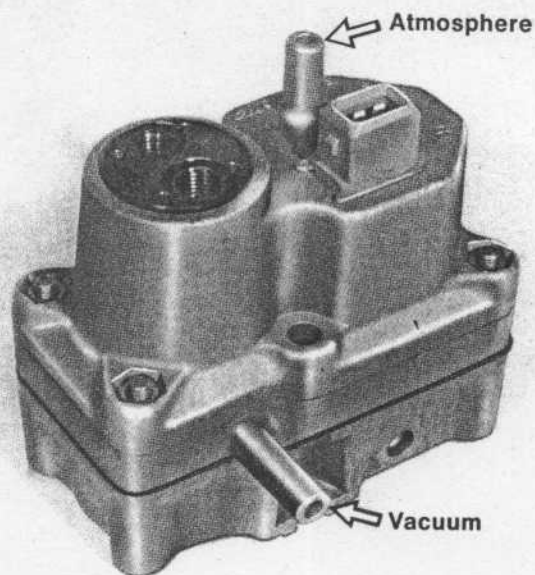

SYSTEM PRESSURE

Testing System Pressure. Engine temperature is not important. Connect pressure tester KDEP 1034 as indicated in *Mounting Pressure Tester*. Bridge the electric safety circuit (see *Electric Wiring Diagram*). Close the pressure tester valve screw leading to the warm-up regulator as shown.

Turn the ignition on. Read the system pressure on the gauge and compare this reading with the value shown on the test sheet.

If system pressure is **lower** than the value given on the test sheet, test the *fuel pump*. If the fuel pump is within specification, adjust the system pressure as indicated below.

If system pressure is **higher** than the value shown on the test sheet, check the gas tank return line for a restriction. If there is no restriction in the return line, adjust the system pressure.

Adjusting System Pressure. If the fuel distributor is fitted **WITH** a push valve, unscrew the large screw plug with attached push valve assembly. Change the adjusting shim as required. A 0.1 mm increase in shim thickness will increase system pressure 0.15 bar (2.2 PSI). Use a new O-ring and copper gasket when reinstalling the large screw plug and push valve. *Note: The piston in front of the shim is matched to the housing and is not replaceable.*

If the fuel distributor is fitted **WITHOUT** a push valve, remove the screw plug and change the adjusting shim as required. A 0.1 mm increase in shim thickness will increase system pressure 0.15 bar (2.2 PSI). Use a new copper gasket when installing the screw plug. Tighten the screw plug to 13 - 15 Nm (10 - 11 ft lbs). *Note: The piston in front of the shim is matched to the housing and is not replaceable.*

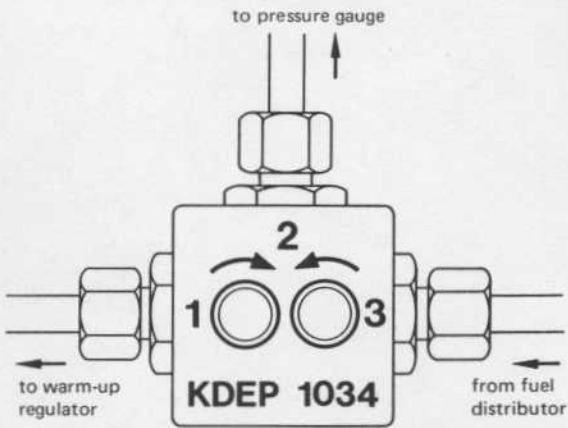

Closing Valve Screw to Warm-up Regulator
(measuring system pressure)

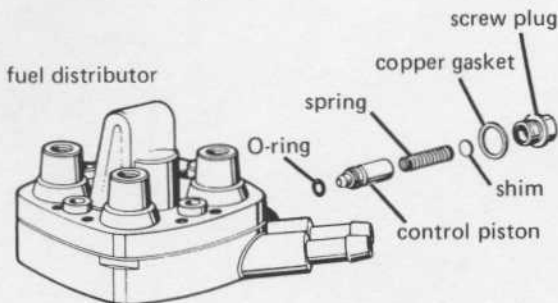

SYSTEM PRESSURE REGULATOR
(without push valve)

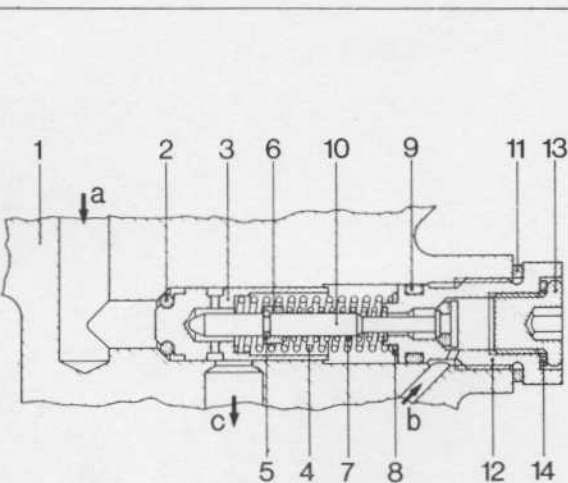

SYSTEM PRESSURE REGULATOR
(with push valve)

- 1 = Fuel distributor housing
- 2 = O-ring
- 3 = Control piston
- 4 = Spring
- 5 = Retainer
- 6 = Retaining ring
- 7 = Spring
- 8 = Shims
- 10 = Valve needle
- 11 = Seal ring
- 12 = Screw plug
- 13 = Screw plug
- 14 = Flat seal ring

- a = from fuel distributor
- b = from warm-up regulator
- c = fuel return

LEAKAGE TEST

The engine must be warm, but not hot. Connect pressure tester KDEP 1034 (see *Mounting Pressure Tester*). Bridge the electric safety circuit (see *Electric Wiring Diagram*). Open both valve screws on the three-way valve as shown.

Turn the ignition on. When warm control pressure is reached, turn the ignition off. After the specified time, the control pressure must NOT be less than the value given on the test sheet for *leakage test*. If control pressure drops too quickly, close the valve leading to the warm-up regulator and repeat the leakage test.

If closing the valve leading to the warm-up regulator brings the pressure into specification, replace the **push valve**, or for fuel distributors without push valves, replace the **warm-up regulator** and/or **throttle activated valve** if fitted (see *Component Repair*).

If closing the valve leading to the warm-up regulator does NOT bring the pressure into specification, there is a leak in the system pressure circuit. Check the **cold start valve** for leakage (see *Cold Start Valve*). Test the **injectors** for leakage (see *Testing Injectors*). If necessary, replace the **check valve** on the electric fuel pump and/or the control piston **O-ring** on the system pressure regulator in the fuel distributor (see *Fuel Distributor Repair*).

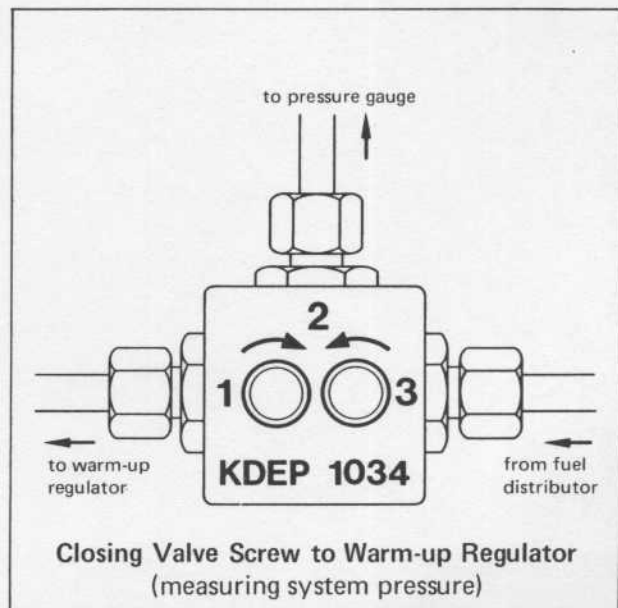
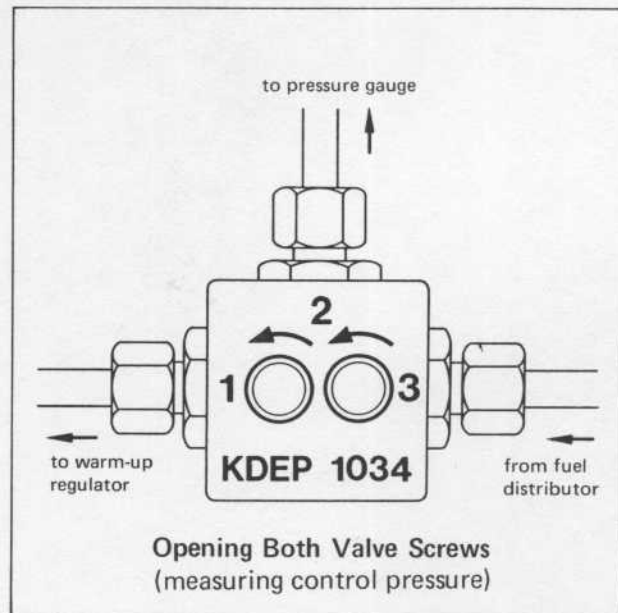

TESTING INJECTORS

Remove the injectors from the engine. Connect each injector to valve tester KDJE 7452 as indicated in the operating instructions included with the tester. Injectors should be tested for opening pressure, leakage and spray pattern. Replace any defective injectors.

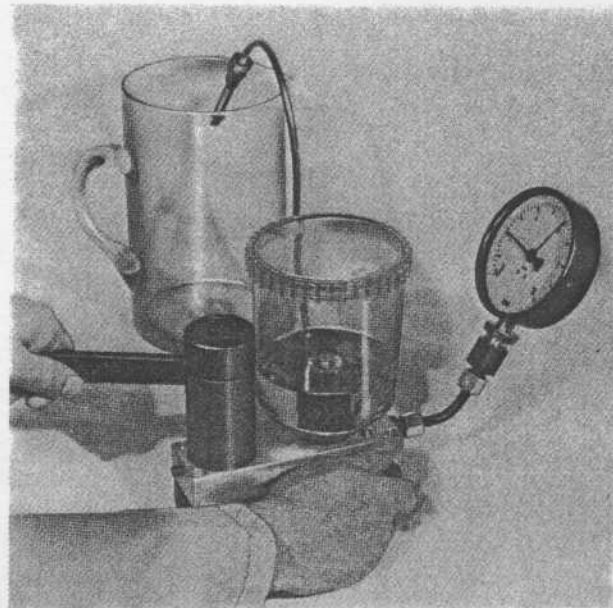

COMPARATIVE TEST

Setting up the tester. Comparative tester KDJE 7451 is used to measure equal delivery between injectors. The comparative test will also determine whether a problem involves an injector or the fuel distributor.

Set the tester on a solid surface next to the vehicle. Level the tester and install the return hose in the gas tank.

If inflexible steel fuel lines are used on the vehicle, remove the steel lines from both the injector and the fuel distributor, and replace them with flexible adapter hoses from accessory kit KDJE 5471/25.

Remove the injectors from the engine and insert each injector, in order, into the tester fuel lines. Tighten the knurled coupling to secure each injector.

Remove the rubber boot (updraft) or air filter (downdraft) from the upper part of the air flow sensor. Bridge the electric safety circuit (see *Electric Wiring Diagram*).

Switch the ignition on to operate the fuel pump. Move the sensor plate to its maximum deflection. Press each of the eight buttons while turning the load range knob back and forth until the rotameter tubes are completely bled. Return the sensor plate to its rest position.

Idle Test. Turn the load range knob to the left to read the left rotameter tube. Press button number 1.

Move the air flow sensor plate by hand until the left rotameter tube shows the value given for *setting point* on the *Idle Delivery Chart*. Fix the sensor plate in this position.

Push each button one after the other until the **lowest** delivery is obtained and then readjust the sensor plate to the setting point value.

Push each button again. Every injector must now be within the tolerance given for *delivery* on the *Idle Delivery Chart*. If not, see *Test Results* below.

IDLE DELIVERY CHART

Cylinders	Setting Point cc/min	Delivery cc/min
4,5,6	6.0	6.0 - 6.8
8	6.0	6.0 - 7.0

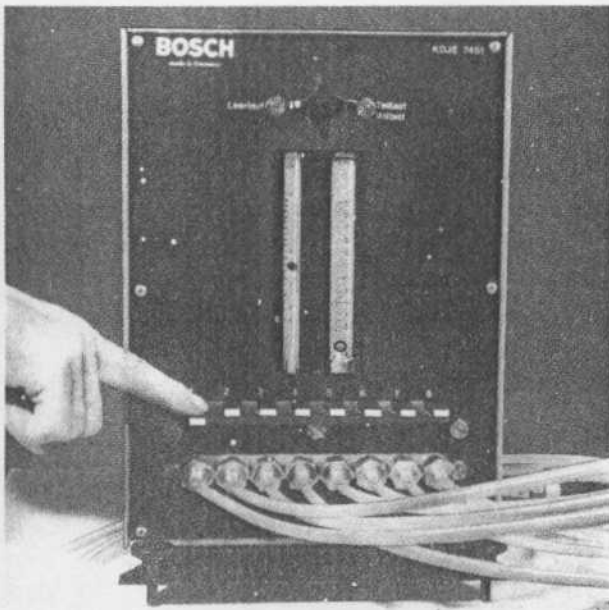
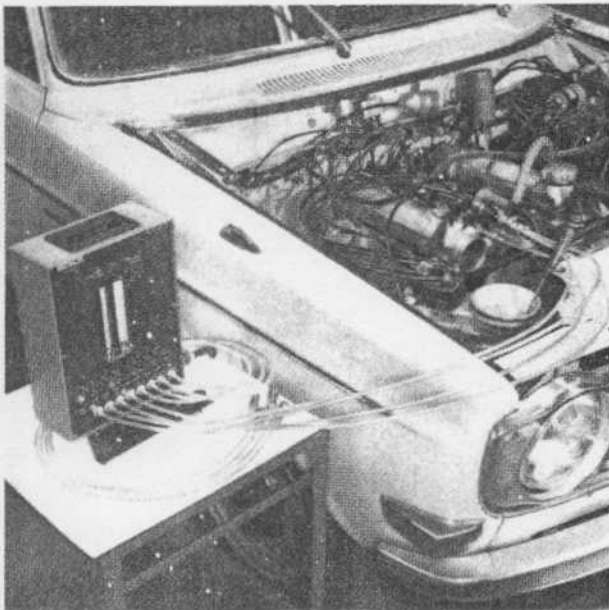
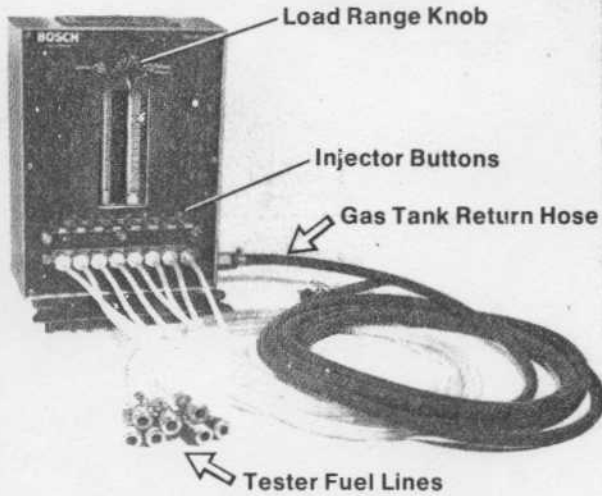

Part Load Test. Turn the load range knob to the right to read the right rotameter tube. Press button number 1. Move the sensor plate by hand until the right rotameter tube shows the value given for *setting point* on the *Part Load Delivery Chart*. Fix the sensor plate in this position.

Push each button until the **lowest** delivery is obtained and then readjust the sensor plate to the setting point value.

Push each button again. Every injector must now be within the tolerance given for *delivery* on the *Part Load Delivery Chart*. If not, see *Test Results* below.

PART LOAD DELIVERY CHART

Cylinders	Setting Point cc/min	Delivery cc/min
4,5,6,8	40.0	40.0 - 44.0

Full Load Test. Move the sensor plate to its maximum deflection. Push each button until the highest delivery is obtained and then readjust the sensor plate until the rotameter tube reads the next lower *setting point* value on the *Full Load Delivery Chart*.

Push each button again. Every injector must be within the appropriate tolerance given for delivery on the *Full Load Delivery Chart*. If not, see *Test Results* below.

FULL LOAD DELIVERY CHART

Cylinders	Setting Point cc/min	Delivery cc/min
4,5,6,8	120.0	120.0 - 131.0
	140.0	140.0 - 153.0
	160.0	160.0 - 175.0

Test Results. Any injector which does not fall within the specified value should be switched with an injector from another cylinder which does fall within the specified value.

If the suspected injector is now within specification, replace the fuel distributor. If the suspected injector is still not within the specified tolerance, replace the injector.

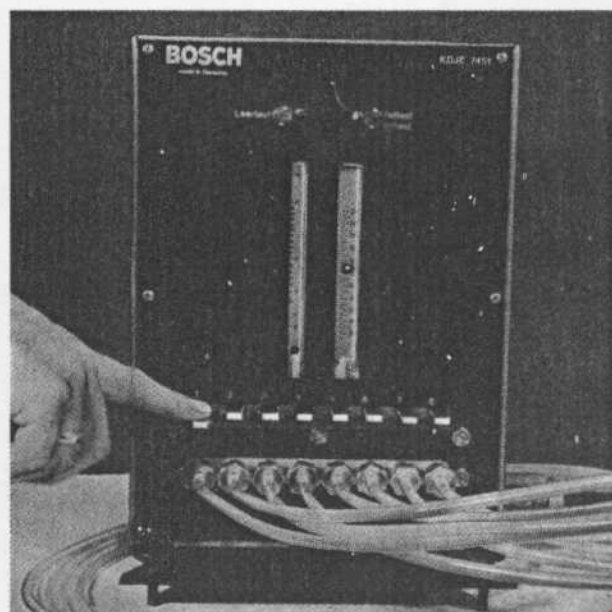
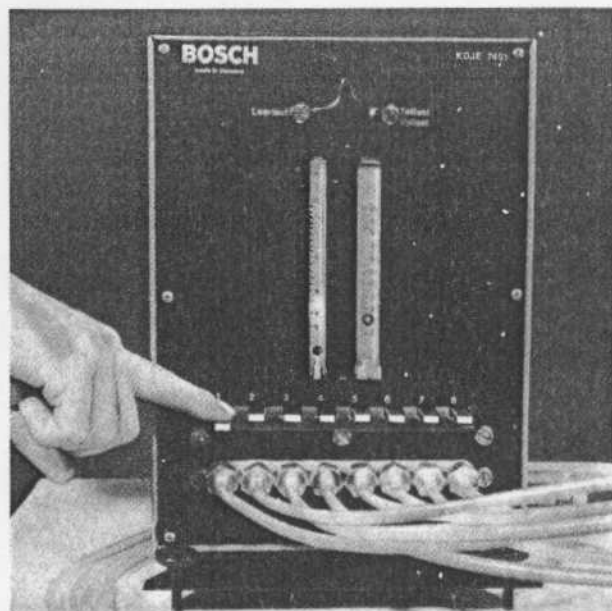

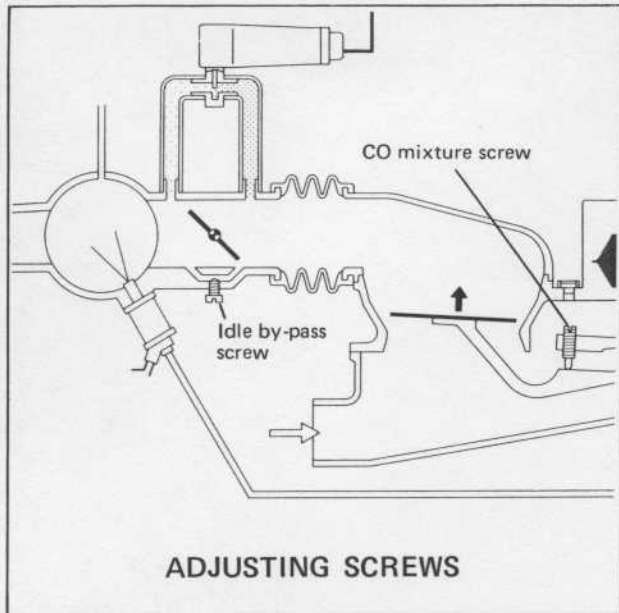

IDLE SPEED AND CO ADJUSTMENT (911 with throttle activated valve)

Preparation. Pressure tester KDEP 1034 must be removed from the vehicle. The electric safety circuit must NOT be bridged. The engine must be warm. If any fuel lines have been opened, warm the engine under load to purge the lines of air. Idle speed and CO specifications are given on the emissions decal in the vehicle engine compartment.

Vehicles with Secondary Air Pump: Remove and plug the pressure hose on the air pump.

Vehicles with Vacuum Limiter: Remove and plug the air hose which connects with the "T" connection above the throttle plate.

Idle Speed Adjustment. Turn the idle bypass screw (arrow) to adjust idle speed.

CO Adjustment. Make the CO adjustment immediately after a test drive (engine at operating temperature). Install the CO sensor in the tailpipe. Remove the sealing plug from the air flow sensor housing. Using wrench KDEP 1035, turn the CO mixture screw out (counterclockwise) to a value leaner than specification. Then, turn the mixture screw in (clockwise) to bring the CO value into specification. Always adjust from the lean side when setting CO. After each adjustment, **remove the wrench** and accelerate the engine to stabilize the mixture. *Accelerating the engine with the wrench in place could bend the air flow sensor lever.*

When the CO adjustment is correct, reconnect the pressure hose to the secondary air pump. The CO value must now be less than 1%. If not, clean the air filter on the secondary air pump with compressed air. Install the plug in the air flow sensor housing and install the vacuum limiter air hose (if fitted).

Testing Throttle Activated Valve. The 1973-74 911S uses a throttle activated valve to energize the start valve. Test the valve by attaching an ohmmeter to the two electrical connections on the throttle activated valve. In the idle position, the ohmmeter must read infinity (circuit open). When the hand throttle (between the seats) is pulled all the way out, the ohmmeter must read zero resistance (circuit closed). If not, adjust the throttle activated valve.

Adjusting Throttle Activated Valve. Insert a 2 mm thick feeler gauge between the idle stop screw and the stop boss. Holding the stop screw against the feeler gauge, turn the stop screw until the throttle circuit just closes (zero resistance on the ohmmeter). It must be possible to press the throttle activated valve switch lever a minimum of 0.5 mm farther downward. Then check again that the electric circuit is closed (zero resistance) when the hand throttle lever is fully pulled.

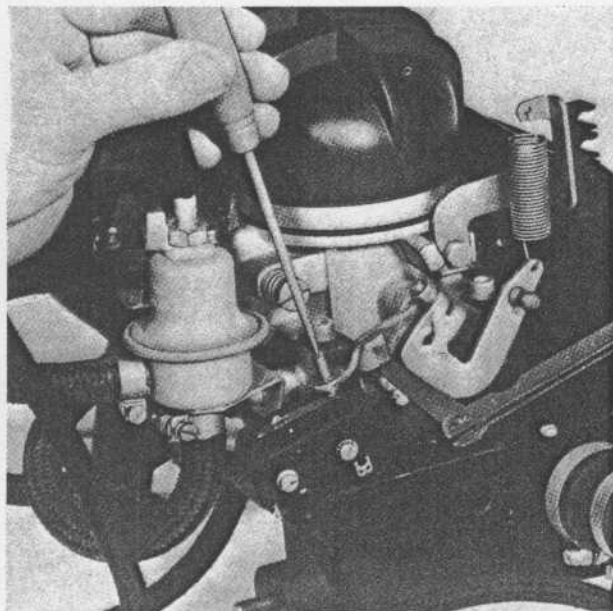
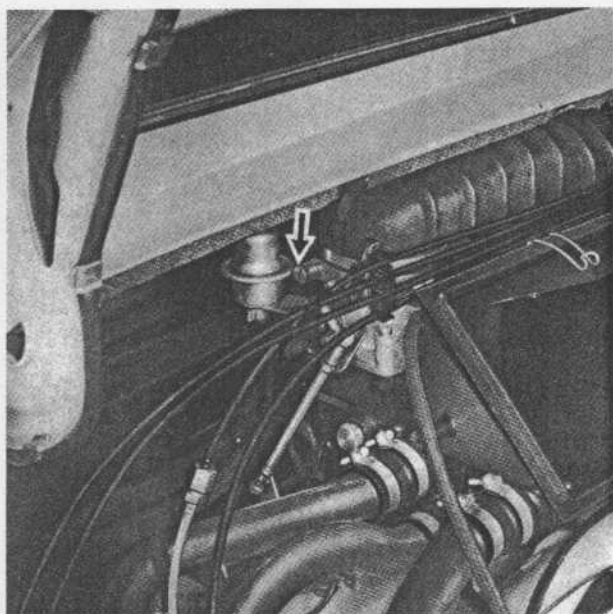

IDLE SPEED AND CO ADJUSTMENT (911 since 1976)

Preparation. Pressure tester KDEP 1034 must be removed from the vehicle. The electric safety circuit must NOT be bridged. The engine must be warm. If any fuel lines have been opened, warm the engine under load to purge the lines of air. Idle speed and CO specifications are given on the emissions decal in the vehicle engine compartment. On 911SC models, make sure the oil tank cover is sealing properly. A leaking oil tank cover will allow unmetered intake air to enter the engine.

Vehicles with Secondary Air Pump: Remove and plug the hose on the secondary air pump check valve as shown.

Vehicles with Vacuum Limiter: Remove and plug the air hose which connects with the "T" connection above the throttle plate.

Idle Speed Adjustment. Turn the idle bypass screw (arrow) to adjust idle speed.

CO Adjustment Install the CO sensor in the tailpipe. If the vehicle has a catalytic converter, install the sensor in the screw plug hole ahead of the converter. This hole must be sealed around the sensor when reading the CO meter.

Remove the sealing plug from the air flow sensor housing. Using wrench KDEP 1035 as shown below, turn the CO mixture screw out (counterclockwise) to a value leaner than specification. Then, turn the mixture screw in (clockwise) to bring the CO value into specification. Always adjust from the lean side when setting CO. After each adjustment, **remove the wrench** and accelerate the engine to stabilize the mixture. *Accelerating the engine with the wrench in place could bend the air flow sensor lever.*

When the CO adjustment is correct, install the plug in the air flow sensor housing, install the secondary air pump pressure hose (if fitted), install the vacuum limiter air hose (if fitted) and install the exhaust pipe screw plug (if fitted).

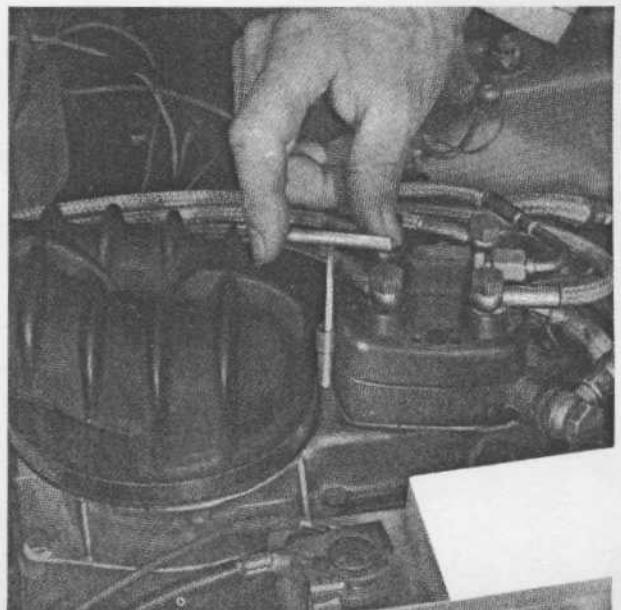
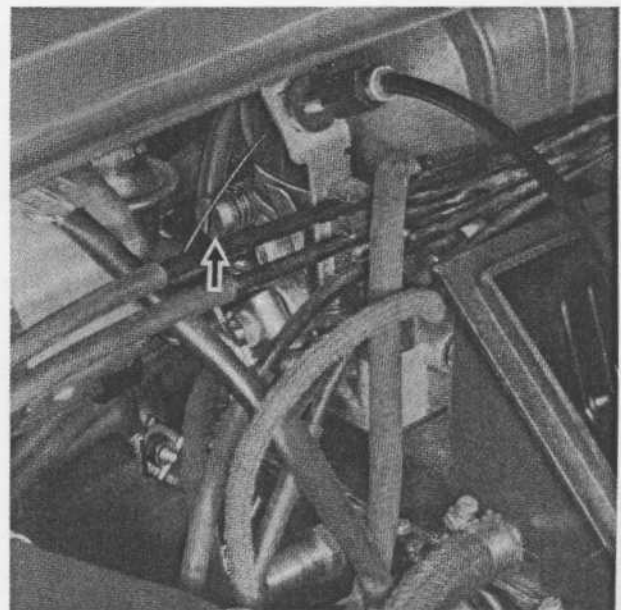
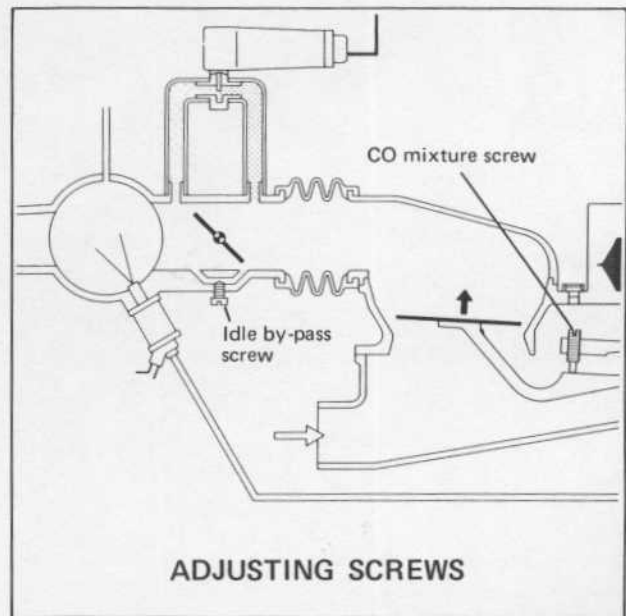

IDLE SPEED AND CO ADJUSTMENT

(924)

Preparation. Pressure tester KDEP 1034 must be removed from the vehicle. The electric safety circuit must NOT be bridged. The engine must be warm (oil temperature approximately 80° C). If any fuel lines have been opened, warm the engine under load to purge the lines of air. Idle speed and CO specifications are given on the emissions decal in the vehicle engine compartment.

Both throttle plate rest positions are set and sealed at the factory. The adjusting screws must not be adjusted.

Clamp the hose between the carbon canister and the air filter as shown above.

Vehicles with Exhaust Gas Recirculation: Remove and plug the vacuum hose on the EGR valve.

Vehicles with Secondary Air Pump: Remove and plug the pressure hose on the air pump.

Vehicles with Vacuum Limiter: Remove and plug the air hose which connects with the "T" connection above the throttle plate.

Idle Speed Adjustment. Turn the idle bypass screw (arrow) to adjust idle speed. The throttle plate position adjusting screws are sealed at the factory and must not be altered.

CO Adjustment. Install the CO sensor in the tailpipe. If the vehicle has a catalytic converter, install the sensor (3) in the screw plug hole (1) ahead of the converter. This hole must be sealed around the sensor when reading the CO meter.

Remove the sealing plug from the air flow sensor housing. Using wrench KDEP 1035, turn the CO mixture screw out (counterclockwise) to a value leaner than specification. Then, turn the mixture screw in (clockwise) to bring the CO value into specification. Always adjust from the lean side when setting CO. After each adjustment, **remove the wrench** and accelerate the engine to stabilize the mixture. *Accelerating the engine with the wrench in place could bend the air flow sensor lever.*

When the CO adjustment is correct, install the plug in the air flow sensor housing, install the EGR vacuum hose (if fitted), install the secondary air pump pressure hose (if fitted), install the vacuum limiter air hose (if fitted) and install the exhaust pipe screw plug (if fitted).

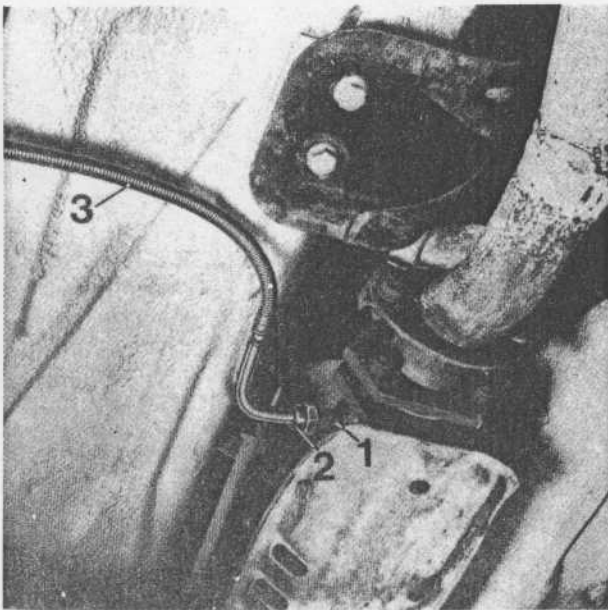
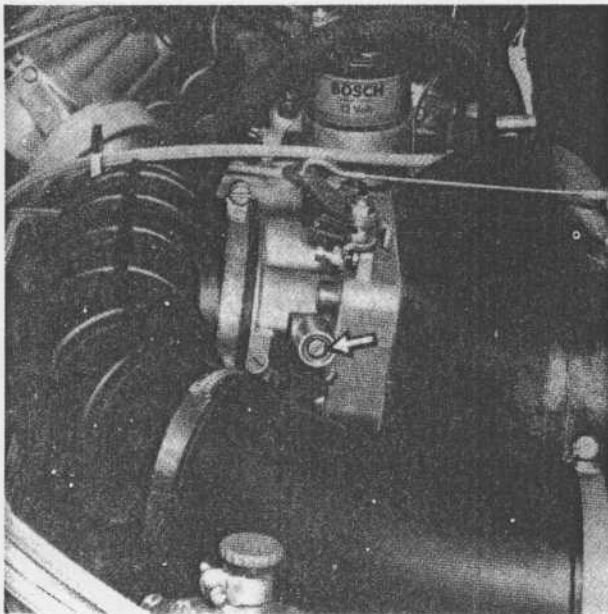
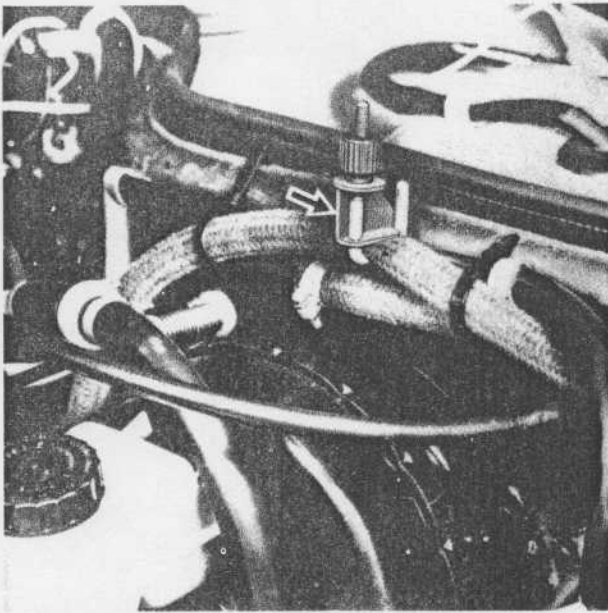

IDLE SPEED AND CO ADJUSTMENT

(928)

Preparation. Pressure tester KDEP 1034 must be removed from the vehicle. The electric safety circuit must NOT be bridged. The engine must be warm (oil temperature 80 - 90° C). If any fuel lines have been opened, warm the engine under load to purge the lines of air. Idle speed and CO specifications are given on the emissions decal in the vehicle engine compartment.

Remove the upper part of the air filter (4 clamps). Remove the right hand air intake hose to expose the **secondary air pump**. Then, remove and plug the pressure hose on the secondary air pump. Replace the upper part of the air filter and the air intake hose.

NOTE: When adjusting idle and CO, make the adjustments quickly to prevent the intake tubes from overheating.

Idle Speed Adjustment. Turn the idle bypass screw in front of the intake manifold to adjust idle speed as shown above.

CO Adjustment. Install the CO sensor in the tailpipe. Insert a 3 mm spherical tip hex wrench (see *Tool List*) in the funnel shaped opening of the air filter housing as shown below until the tip of the wrench engages in the top of the spring loaded sealing plug (arrow). Push the sealing plug down (about 18 mm) until the plug engages with the idle mixture screw. Now, turn the idle mixture screw counterclockwise to a value leaner than specification. Then, turn the mixture screw clockwise to bring the CO value into specification.

Always adjust from the lean side when setting CO. After each adjustment, **remove the wrench** and accelerate the engine to stabilize the mixture and cool the intake tubes. When the hex wrench is withdrawn, the spring loaded sealing plug seals the opening to prevent unmetered air from entering the engine. *Accelerating the engine with the wrench in place could bend the air flow sensor lever.*

When the CO adjustment is correct, install the secondary air pump pressure hose.

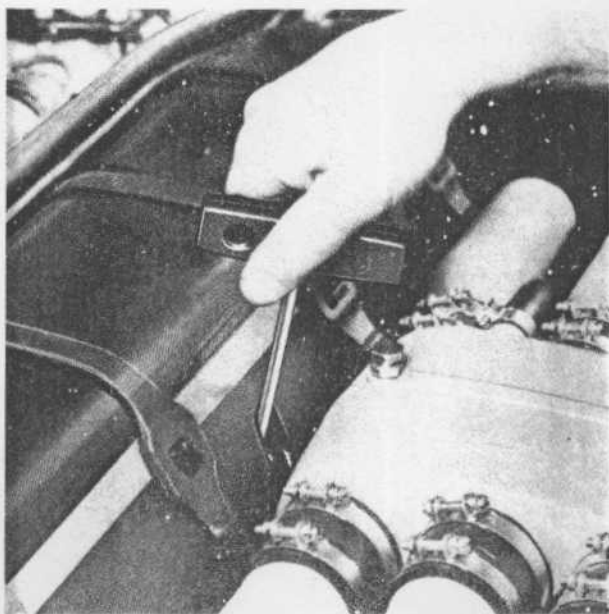
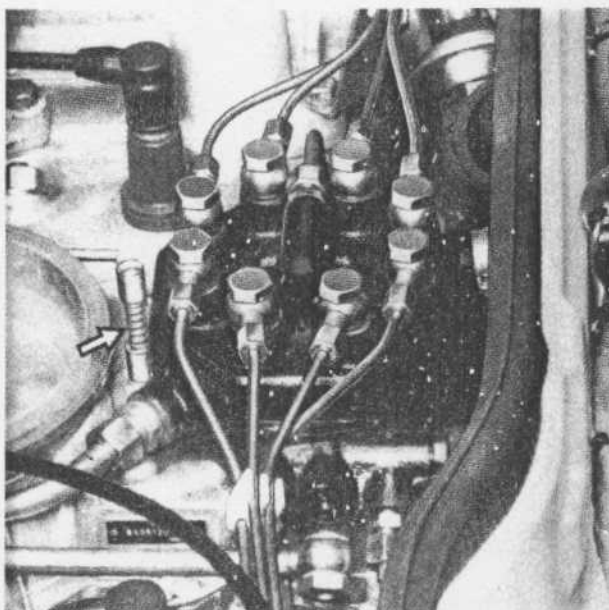
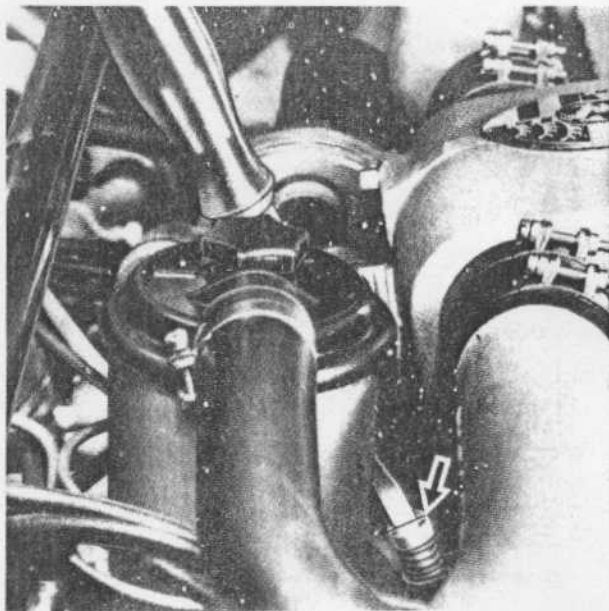

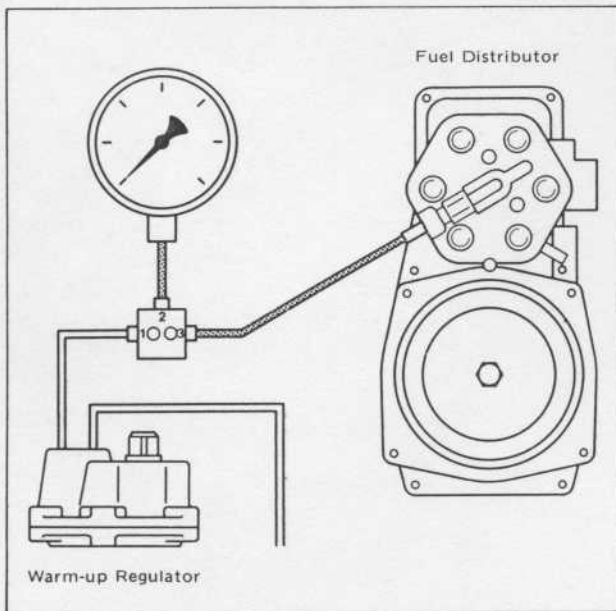

MOUNTING PRESSURE TESTER

Preparation. Pressure tester KDEP 1034 was initially supplied with a three-way changeover valve operated by a single lever. In newer models this lever is replaced by a directional control valve with two hollow screws. The connections on the directional control valve and the changeover valve are numbered the same.

The pressure tester is connected in the control pressure line between the warm-up regulator and the fuel distributor as shown.

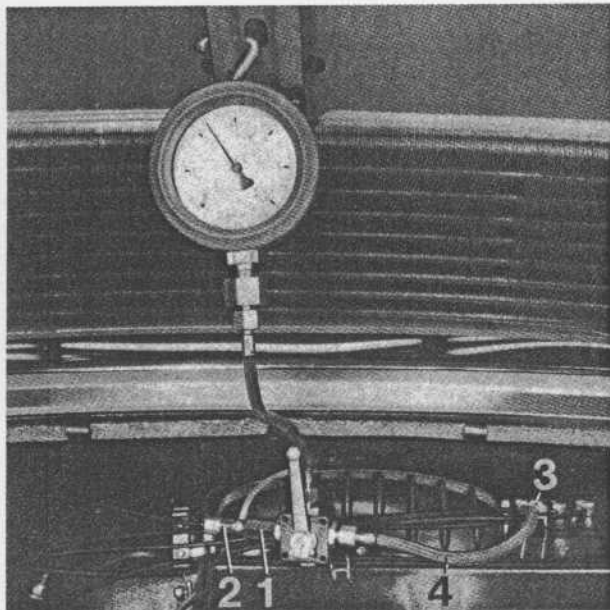

For 911S models with throttle activated valve: Clean the fuel fittings on the warm-up regulator. At the **fuel distributor**, unscrew both the control pressure line coming from the **throttle activated valve** and the control pressure line coming from the **warm-up regulator**. Using adapter KDEP 1034/10/1 and one of the original hollow screws, attach both pressure lines to connection 1 of the tester valve.

Screw connector piece KDEP 1034/10/2 into the control outlet hole of the fuel distributor. Attach connection 3 of the tester valve to the connector piece in the fuel distributor.

Attach connection 2 to the pressure gauge with the other connecting hose. Bleed the tester as indicated below.

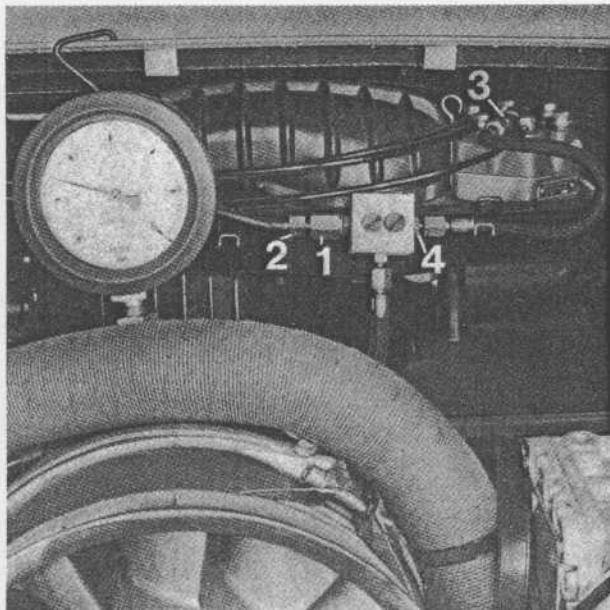

For 911 models without throttle activated valve: Clean the fuel fittings on the control pressure line at the fuel distributor. Unscrew the **control pressure line** from the **fuel distributor**. Using adapter KDEP 1034/10/3, attach the control pressure line to connection 3 of the valve tester.

Unscrew the fitting left in the control pressure outlet of the fuel distributor and install connecting piece KDEP 1034/10/2 in its place. Using a connecting hose, attach connection 1 of the tester valve to the connecting piece in the fuel distributor .

Attach connection 2 to the pressure gauge with the other connecting hose. Bleed the tester as indicated below.

For 924 models: Clean the fuel fittings for the control pressure line on the fuel distributor. Unscrew the **control pressure line** from the **fuel distributor** and attach the line to connection 1 on the tester valve as shown. Attach connection 3 of the tester valve to the fuel distributor with the connecting hose. Attach connection 3 of the tester valve to the fuel distributor with the connecting hose.

Attach connection 2 to the pressure gauge with the other connecting hose. Bleed the tester as indicated below.

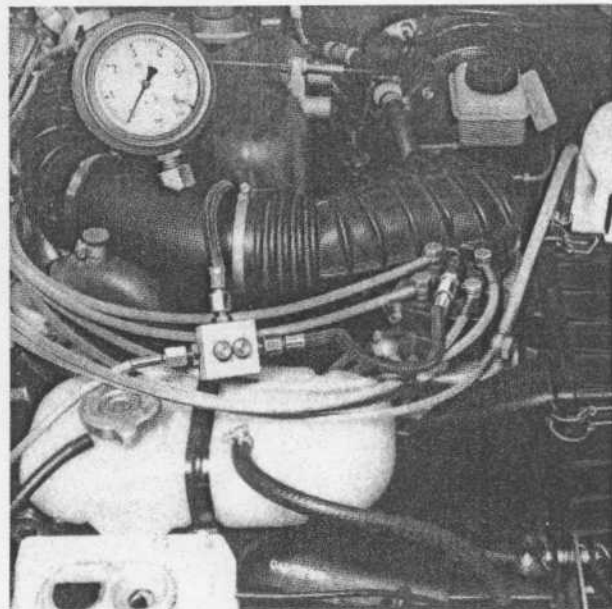

For 928 models: Clean the fuel fittings on the control pressure line at the warm-up regulator. Remove the **control pressure line** from the **warm-up regulator**. Using the hose included in connecting parts set KDEP 1034/11, connect the warm-up regulator outlet with connection 1 of the tester valve.

Attach the two piece connector (included in connecting parts set KDEP 1034/11) to the control pressure line. Using the tester hose, connect the control pressure line to connection 3 of the tester valve.

Attach connection 2 to the pressure gauge with the other connecting hose. Bleed the tester as indicated below.

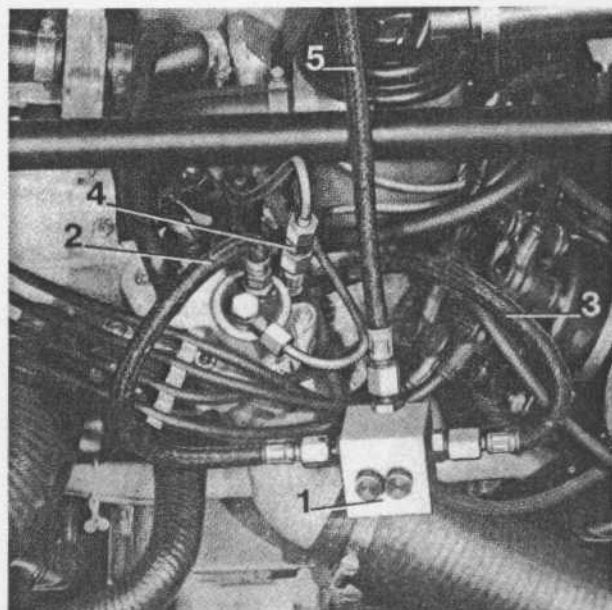

Bleeding the Tester. Disconnect the electric plug from the warm-up regulator and the auxiliary air valve. With the tester hoses fully extended, let the gauge hang down under its own weight so that the gauge is lower than the fuel lines.

Bridge the electric safety circuit and switch the ignition on to run the fuel pump. If the changeover valve is used, move the control lever back and forth about five times between position 2 and 3, remaining in each position about 10 seconds. If the directional control valve is used, open and close hollow screw number 1 about five times, remaining in each position approximately 10 seconds. Turn the ignition off.

Hang the gauge from one of the struts under the engine hood or other suitable support and proceed with the appropriate pressure test.

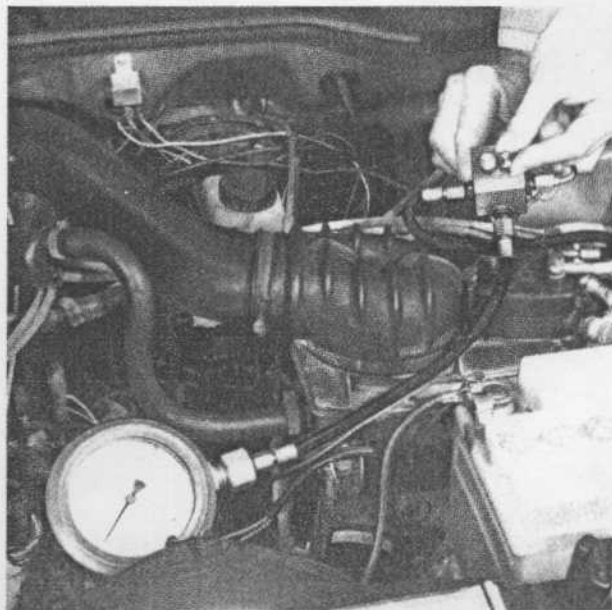

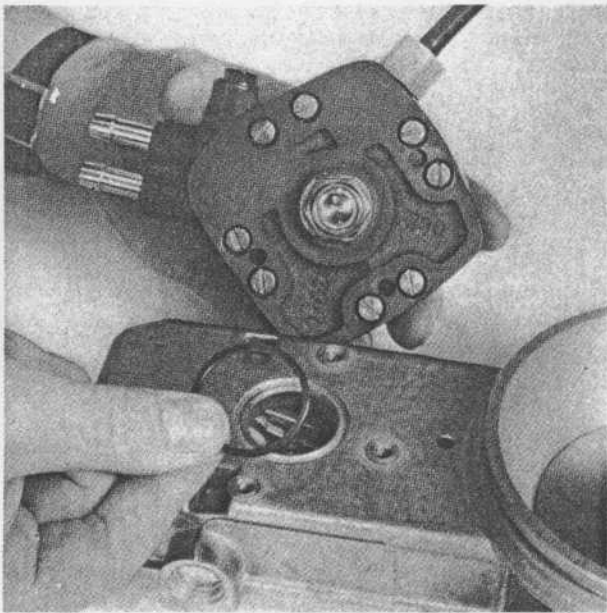

FUEL DISTRIBUTOR REPAIR (911,924)

Removal. Clean all the fuel fittings on the fuel distributor. Remove all fuel connections. Unscrew the three fastening screws and remove the fuel distributor from the air flow sensor housing or throttle valve housing. Be careful not to let the plunger fall out. Keep shims and springs together.

Installation. When installing the 911 air flow sensor housing on the intake manifold, tighten the fastening screws until each spring is compressed, then loosen each screw one turn.

Rinse the plunger in an appropriate solvent and reinstall the plunger in the fuel distributor. Install the fuel distributor on the air flow sensor using a new gasket as shown. Tighten the fastening screws to exactly 3.2 - 3.8 Nm (2.4 - 2.8 ft lbs). Attach all fuel lines except one (arrow) to the fuel distributor using new gaskets.

Bridge the electric safety circuit (see *Electric Wiring Diagram*). Turn the idle mixture screw in clockwise slowly, without pushing on the air flow sensor lever, until fuel just starts to come out the open fuel outlet. Then, turn the screw out counterclockwise $\frac{1}{2}$ turn.

Reconnect the fuel line to the fuel distributor. Run the engine until it reaches operating temperature and make the final mixture adjustments as indicated in *Idle and CO Adjustment*.

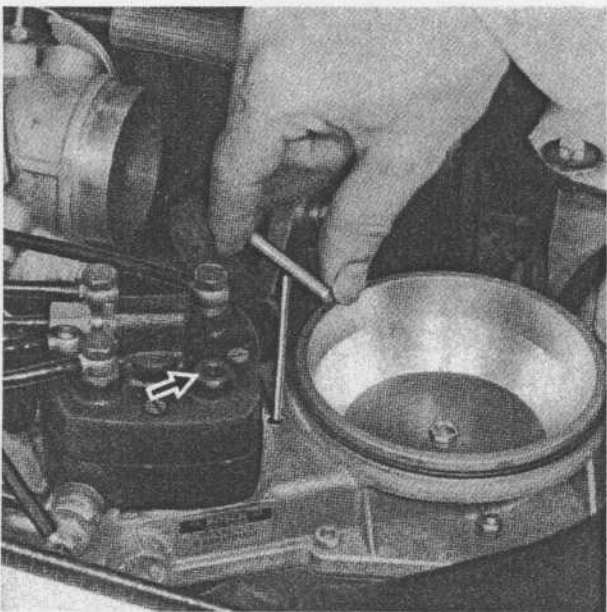

FUEL DISTRIBUTOR REPAIR (928)

Removal. Remove both intake hoses and the upper part of the air filter (4 clamps). Remove the pressure screw in the intake manifold. Remove the fastening screws in the air filter bowl (arrows). Then, remove the filter bowl to the right. Clean all the fuel fittings on the fuel distributor. Remove all fuel connections. Unscrew the three fastening screws and remove the fuel distributor from the air flow sensor. Be careful not to let the plunger fall out.

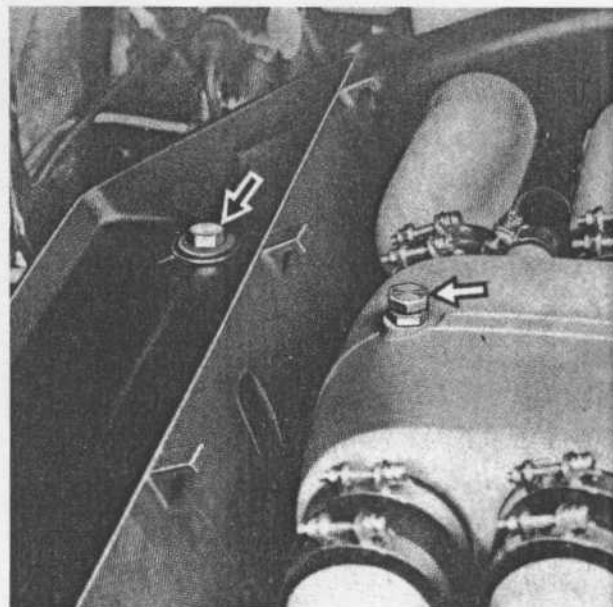

Installation. Rinse the plunger in an appropriate solvent and reinstall the plunger in the fuel distributor. Install the fuel distributor on the air flow sensor using a new gasket as shown. Tighten the fastening screws to exactly 3.2 - 3.8 Nm (2.4 - 2.8 ft lbs). Attach all fuel lines except one (arrow) to the fuel distributor using new gaskets.

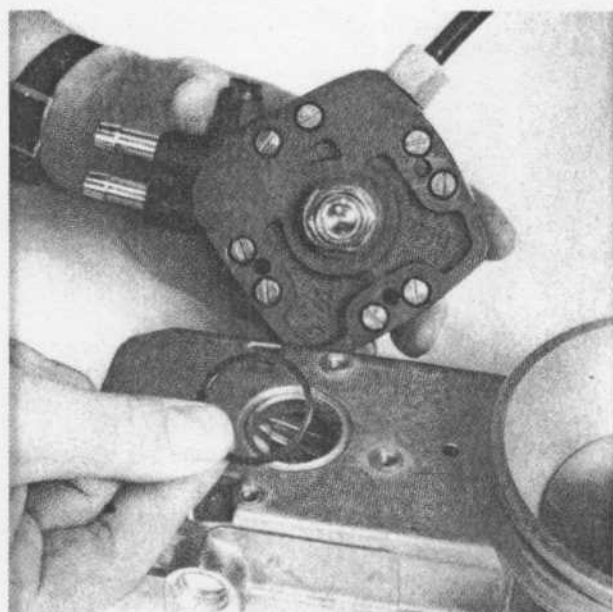

Bridge the electric safety circuit (see *Electric Wiring Diagram*). Turn the idle mixture screw in clockwise slowly, without pushing on the air flow sensor lever, until fuel just starts to come out the open fuel outlet. Then, turn the screw out counterclockwise $\frac{1}{2}$ turn.

Reconnect the fuel line to the fuel distributor. Run the engine until it reaches operating temperature and make the final mixture adjustments as indicated in *Idle and CO Adjustment*.

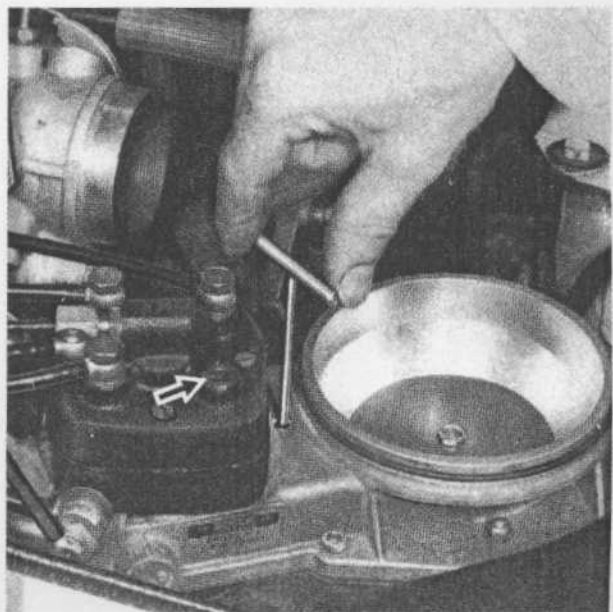

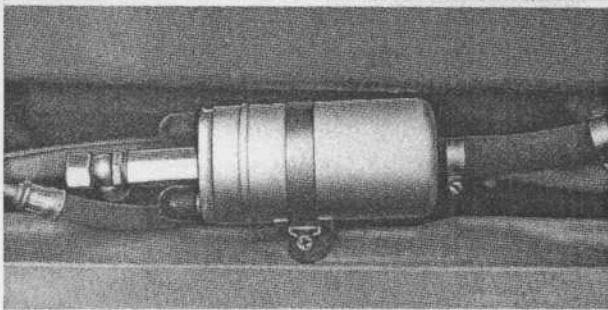
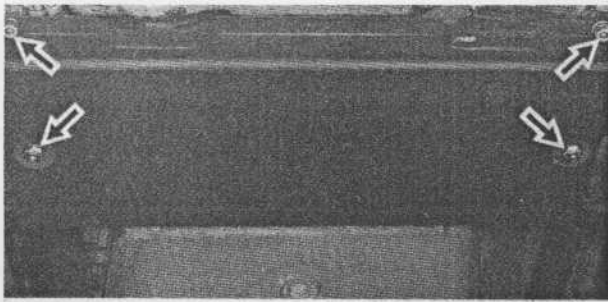

FUEL PUMP REPAIR

Remove any dirt protection plates to expose the fuel pump. See *Component Location* for exact position of fuel pump components.

Clean all fuel fittings and clamp the inlet hose to prevent fuel from escaping before removing any fuel pump components.

On 1973-74 Porsche 911 models, remove the inlet hose from the union fitting after loosening the hose clamp.

On 1975 Porsche 911 models with polyamide fuel lines, remove the fuel pump together with the complete fuel line. The inlet fuel line should be removed from the pump on the bench. Hold the pump by hand, NOT in a vise. Torque the union fitting to exactly 16 - 20 Nm (12 - 15 ft lbs).

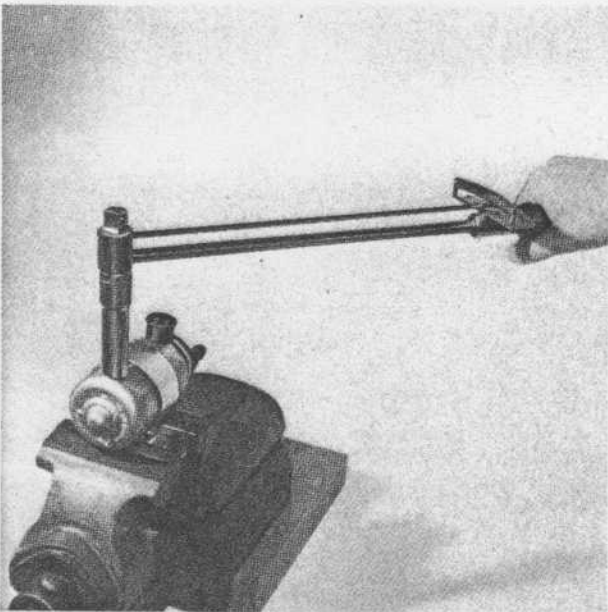

Steel Housing with Side Fuel Fitting. Clean the fuel fittings on the electric fuel pump. Remove and thoroughly clean the fuel pump. Mount the clamp for the fuel pump in a vise as shown. Do NOT clamp the fuel pump housing itself in a vise.

Unscrew the check valve from the side of the pump. No dirt must enter the pump. Install a new check valve using a new gasket and tighten to exactly 16 - 20 Nm (12 - 15 ft lbs).

Aluminum Housing with Internal Check Valve. The check valve on fuel pumps with internal check valves cannot be replaced. If the check valve is leaking, the complete fuel pump must be replaced.

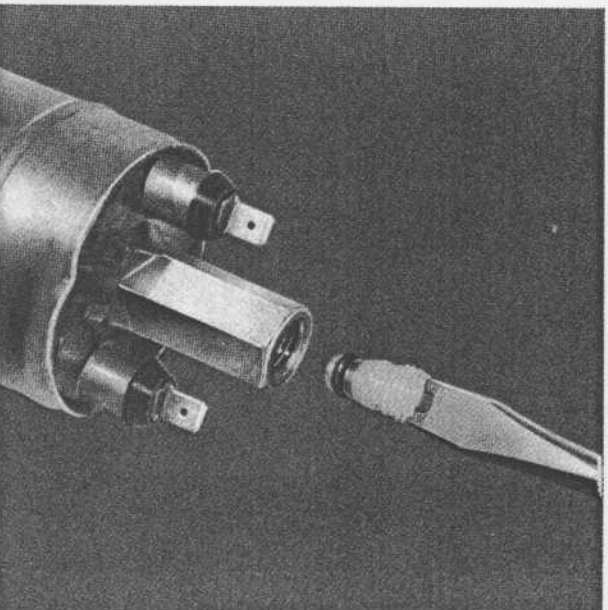

Aluminum Housing with Threaded Check Valve. Clean the fuel fittings and remove the fuel pump. Unscrew the valve insert using a special slotted screwdriver (9 mm wide blade, 4 mm wide slot). No dirt must enter the pump.

Install a new check valve using a new O-ring and tighten to 0.4 - 0.6 Nm (3.5 - 5.3 in lbs). Be careful not to overtighten the check valve and damage the delicate plastic threads.

Caution: On 1976 and later Porsche 911 models, the fastening screws which secure the protective plate also fasten part of the front axle support and stabilizer bar. Be sure to tighten the protective plate **socket head screws** to 47 Nm (35 ft lbs) and the protective plate **self-locking nuts** to 28 Nm (21 ft lbs). Self-locking nuts which have been reused several times should be replaced with new ones.

PRESSURE REGULATOR REPAIR

Clean the fuel distributor, especially around the system pressure regulator. Remove the screw plug (large screw plug and push valve if fitted), shim, spring and needle valve. Replace the O-ring behind the control piston. Be careful not to damage the needle valve during removal and assembly.

Install the control piston, spring, shim, (push valve if fitted), and the screw plug using a new gasket. Tighten the screw plug to 13 - 15 Nm (10 - 11 ft lbs).

Check the *system pressure* and adjust as necessary.

The needle valve and large screw plug on push valve type distributors are only replaced together as a unit.

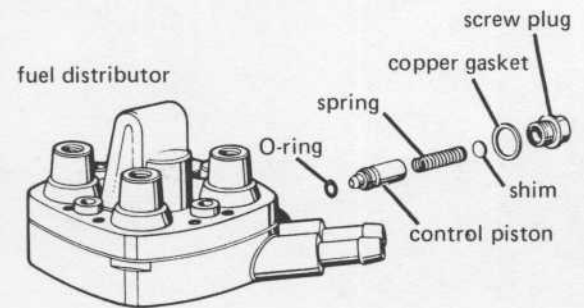

SYSTEM PRESSURE REGULATOR
(without push valve)

- 1 = Fuel distributor housing
- 2 = O-ring
- 3 = Control piston
- 4 = Spring
- 5 = Retainer
- 6 = Retaining ring
- 7 = Spring
- 8 = Shims
- 10 = Valve needle
- 11 = Seal ring
- 12 = Screw plug
- 13 = Screw plug
- 14 = Flat seal ring

a = from fuel distributor
b = from warm-up regulator
c = fuel return

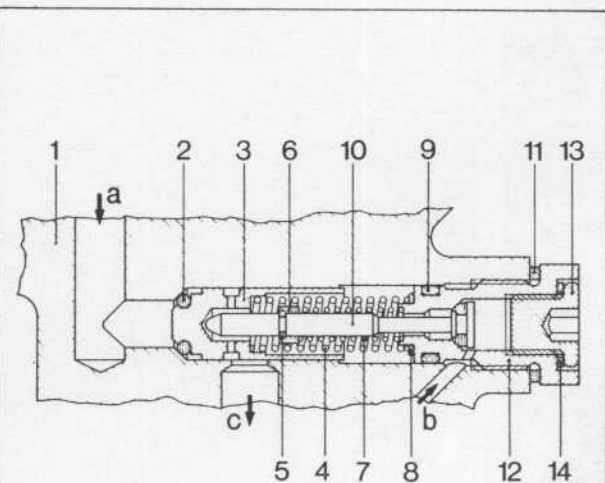

SYSTEM PRESSURE REGULATOR
(with push valve)

WARM-UP REGULATOR REPAIR (911)

Removal. Remove intake hose 1 from the auxiliary fan housing. Loosen hose clamps 2 and 3 and remove the hoses from the auxiliary fan housing. Note: 911SC models require removal of a plastic rivet in each hose. Loosening screw 4 and tilting the fan motor upwards will make the hose removal easier.

Installation. Replace the warm-up regulator as required and reassemble in the reverse order.

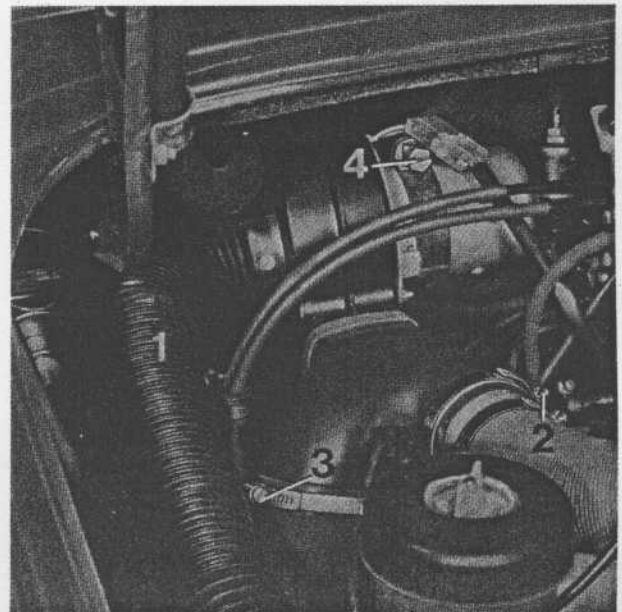

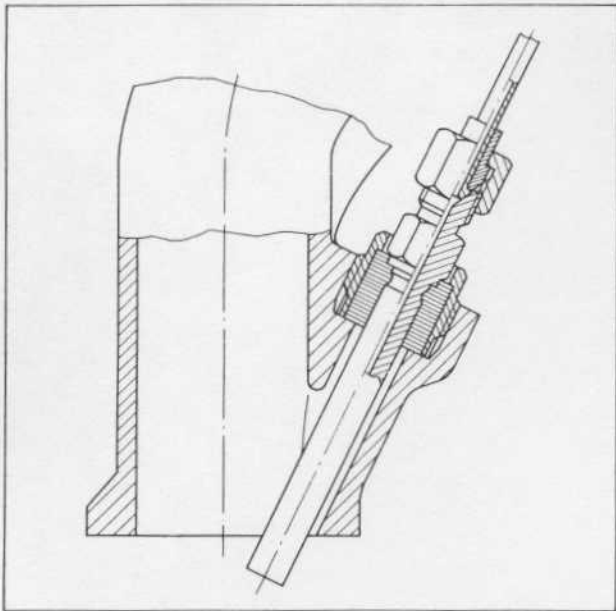

INJECTOR REMOVAL (928)

The injectors are held in place by a rubber bushing mounted in a threaded sleeve.

To remove the threaded sleeve, turn the fixed hex part of the injector as shown.

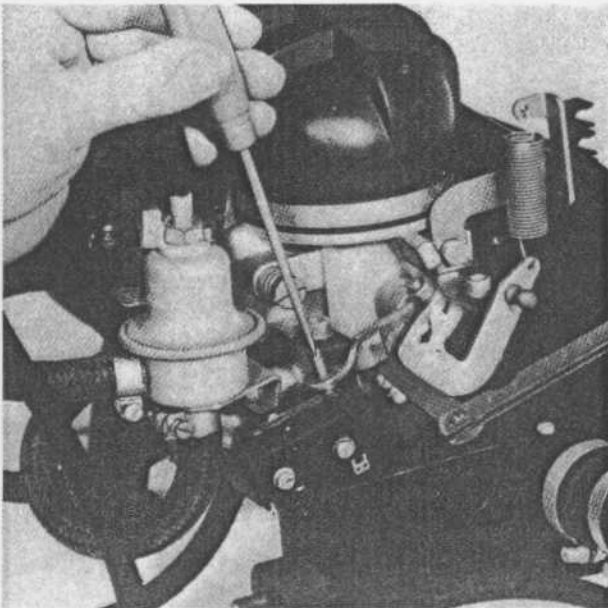
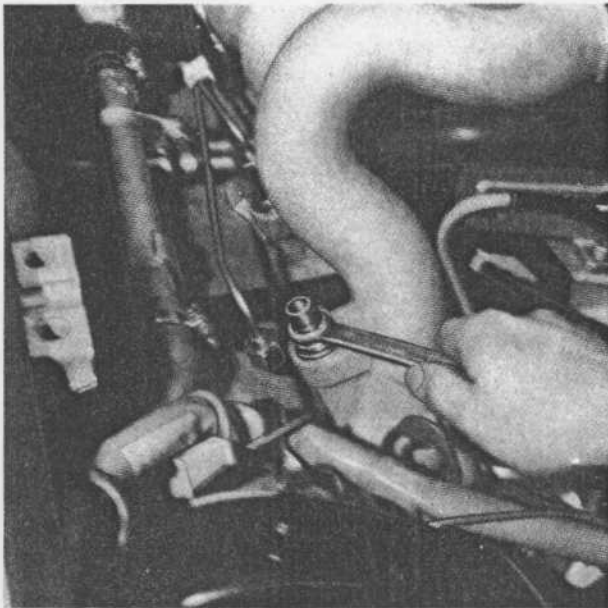

THROTTLE ACTIVATED VALVE

Removal. Remove the venturi assembly from the intake manifold. Remove the throttle activated valve from the throttle shaft.

Installation. Install the new throttle activated valve on the throttle shaft. Replace the venturi assembly on the intake manifold.

Adjust the **warm control pressure** idle value (see *Warm-Up Regulator with Full Load Enrichment - Warm Control Pressure WITH Throttle Activated Valve*). Tighten both fastening screws.

ELECTRIC WIRING DIAGRAM

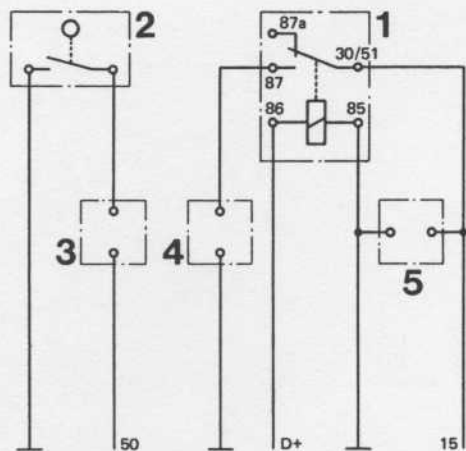

911 (1973 2.4 I)

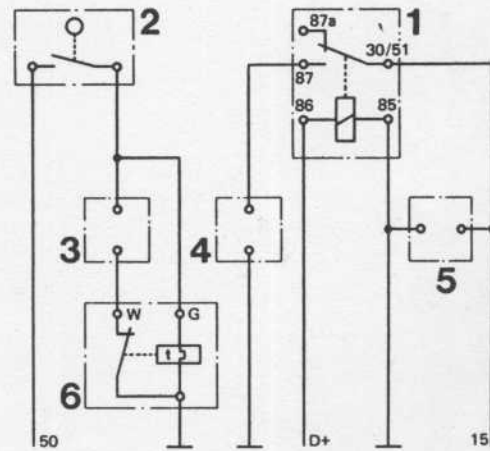

911, 911S (1974-75 2.7 I)

- 1 = Relay
- 2 = Throttle Valve Switch
- 3 = Start Valve
- 4 = Warm-up Regulator
- 5 = Electric Fuel Pump
- 6 = Thermo-time Switch

Bridging the electric safety circuit. Remove the relay from the mounting bracket. Bridge the circuit with a fused (8 amp) jumper between terminals 30/51 and 87 (see *Component Location*). NOTE: The fuel pump relay and warm-up regulator relay are not mounted in the same place on all vehicles. Be sure to remove the fuel pump relay to bridge the safety circuit.

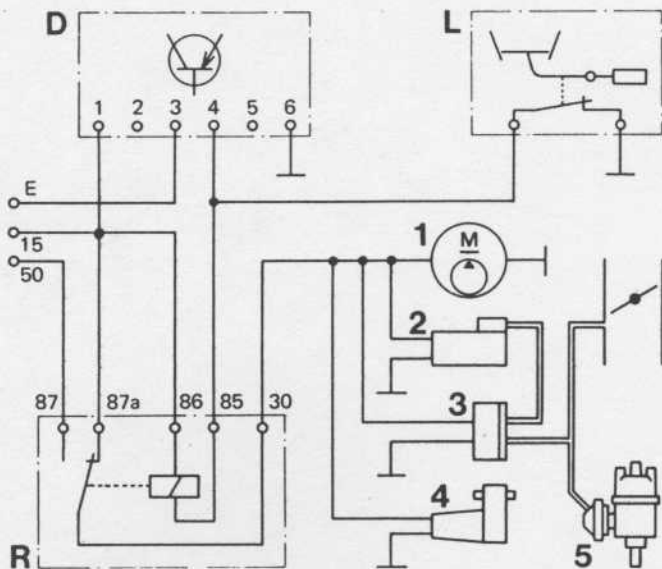

911, 911S, 911SC (since 1976)

- 1 = Electric Fuel Pump
- 2 = Warm-up Regulator
- 3 = Thermovalve
- 4 = Auxiliary Air Valve
- 5 = Ignition Distributor
- R = Thermo-time Switch
- L = Air Flow Sensor Switch
- D = Electronic Relay

Bridging the electric safety circuit. The electric safety circuit can be bridged by disconnecting the air flow sensor plug or by bridging terminals 30 and 87a with a fused (8 amp) jumper wire.

ELECTRIC WIRING DIAGRAM

924

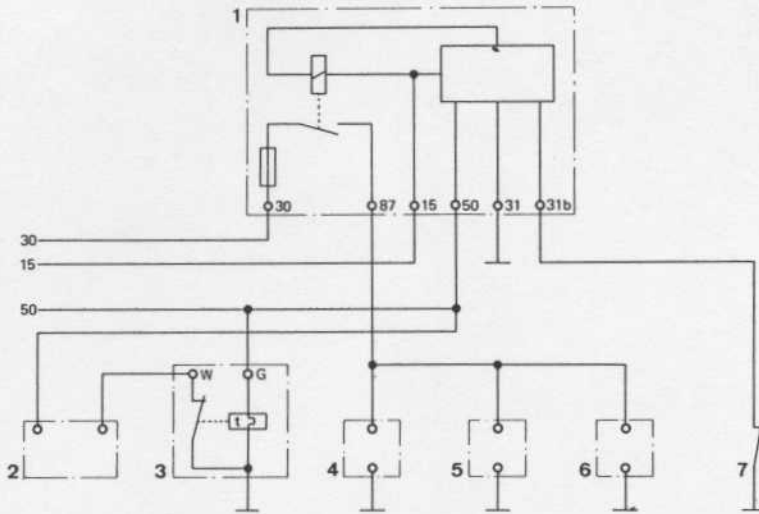

- 1 = Electronic Relay
- 2 = Start Valve
- 3 = Thermo-time Switch
- 4 = Electric Fuel Pump
- 5 = Warm-up Regulator
- 6 = Auxiliary Air Device
- 7 = Air Flow Sensor Contact

Bridging the electric safety circuit. Disconnect the plug from the air flow sensor.

928

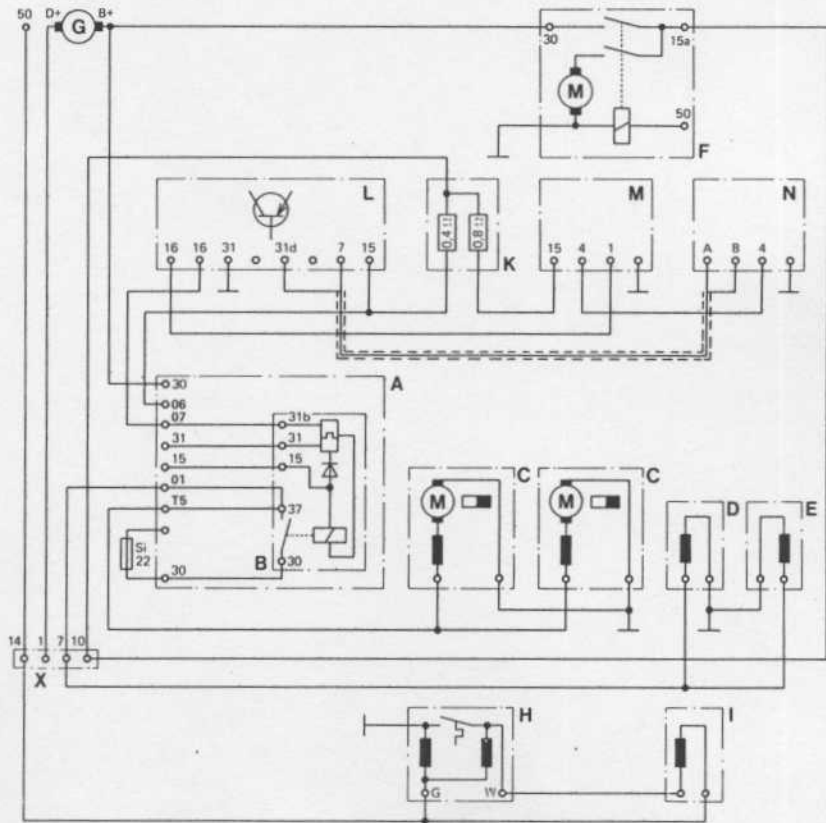

- A = Central Electrics Base Assembly
- B = Fuel Pump Relay No. XVII
- C = Fuel Pumps
- D = Warm-up Regulator
- E = Auxiliary Air Device
- F = Starting Motor
- G = Alternator
- H = Thermo-time Switch
- I = Start Valve
- K = Ballast Resistors for Ignition Transformer
- L = Trigger Box TCI
- M = Ignition Transformer
- N = Ignition Distributor
- Si = Fuse

- 06 Plug connections at central electrics base assembly
- 07
- 01
- T5

X = 14 pin plug in engine compartment

Bridging the electric safety circuit. Remove relay No. XVII located in the lower part of the passenger compartment (see *Component Location*).

SERVICE PARTS LIST

Porsche

Illustration Number	Description	Bosch Part No.	
1	Fillister Head Screw	911	2 910 022 174
		924	2 910 022 172
2	Washer		2 916 710 649
3	Shim .1 mm .5 mm		2 430 000 090
			2 430 000 094
4	Spring		2 434 611 030
5	O-ring		2 430 210 003
6	Seal	911	2 430 210 013
		924	2 430 210 036

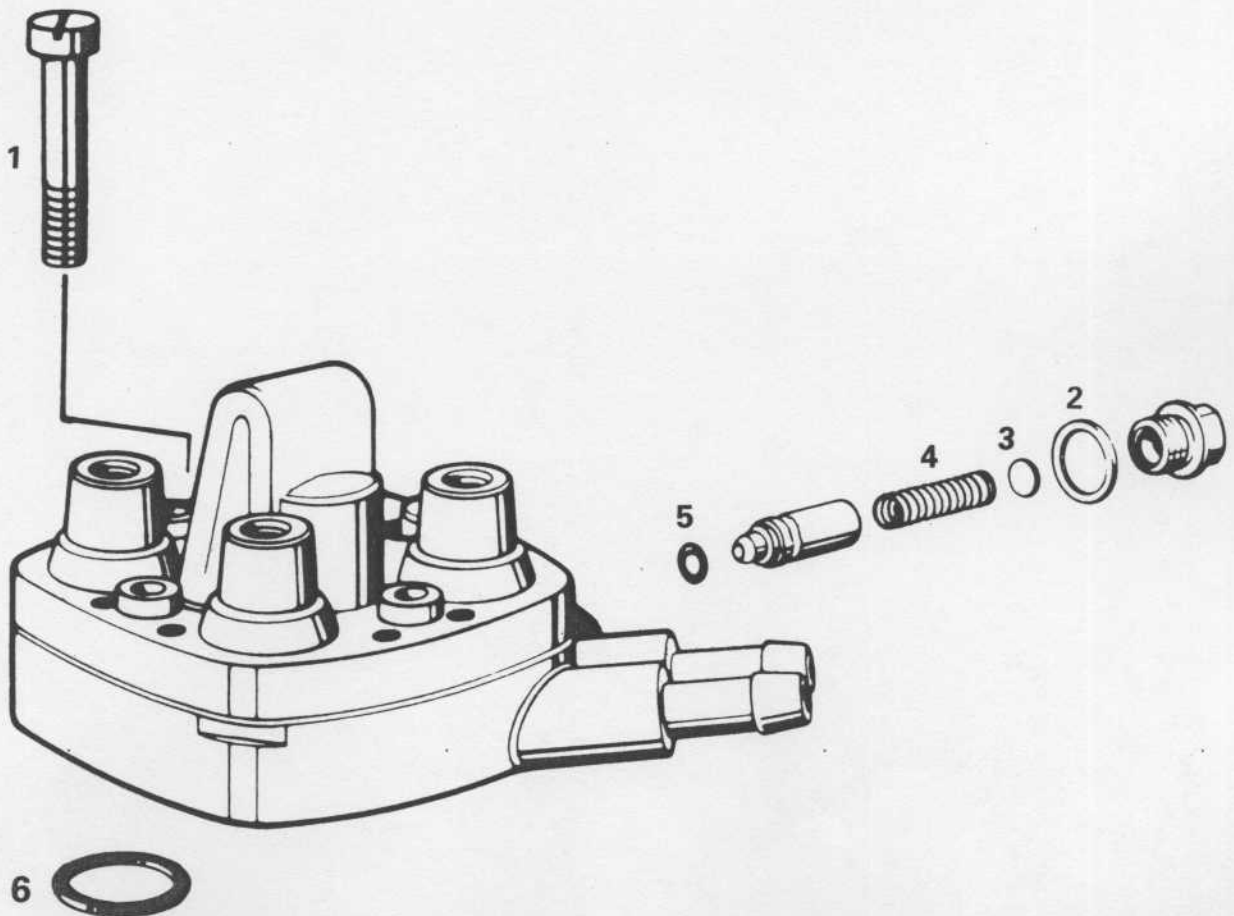

FUEL PUMP: min. 750 cc in 30 seconds

COLD CONTROL PRESSURE

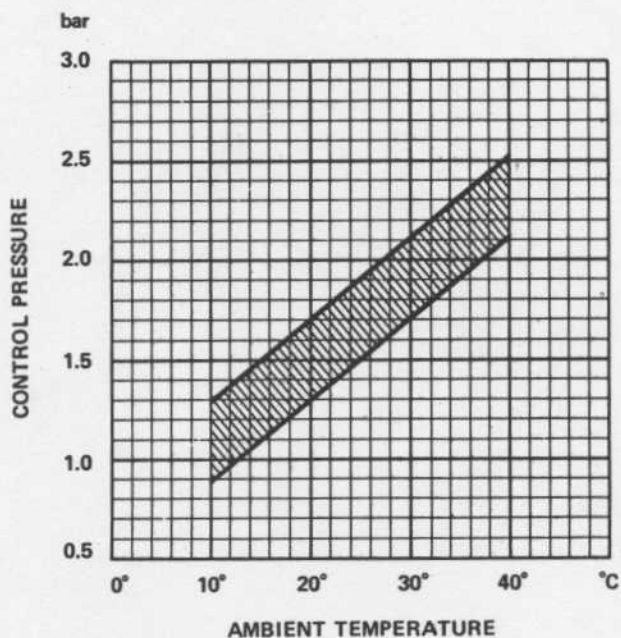

0 438 140 011

WARM CONTROL PRESSURE: 3.4 - 3.8 bar

SYSTEM PRESSURE

Checking Value: 4.5 - 5.2 bar
 Setting Value: 4.7 - 4.9 bar

LEAKAGE TEST

Minimum pressure after 10 minutes: 1.7 bar

Minimum pressure after 20 minutes: 1.5 bar

INJECTION VALVE OPENING PRESSURE: 2.5 - 3.6 bar

Idle speed and CO specifications are given on the emissions decal in the vehicle engine compartment.

FUEL PUMP: min. 750 cc in 30 seconds

COLD CONTROL PRESSURE

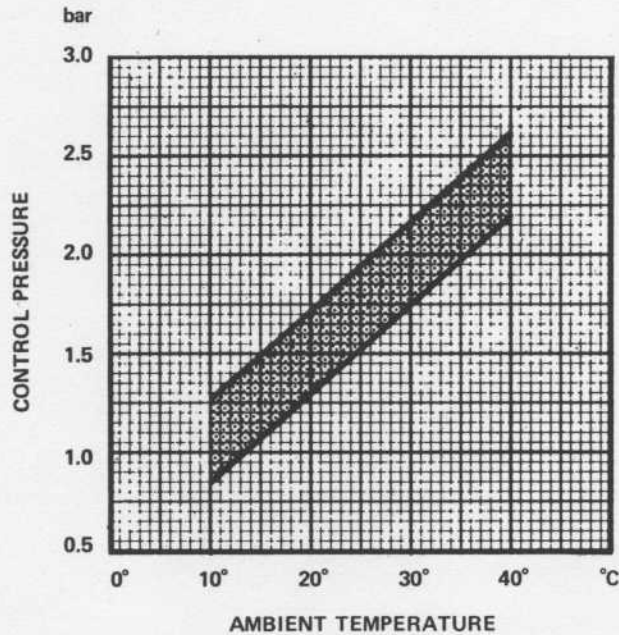

0 438 140 001

WARM CONTROL PRESSURE (throttle plate adjustment)

Idle

checking value: 2.8 - 3.0 bar

setting value: 2.85 - 2.96 bar

Part load: 3.4 - 3.8 bar

Full load: 2.6 - 3.0 bar

SYSTEM PRESSURE

Checking Value: 4.5 - 5.2 bar

Setting Value: 4.7 - 4.9 bar

LEAKAGE TEST

Minimum pressure after 20 minutes: 1.0 bar

INJECTION VALVE OPENING PRESSURE

2.5 - 3.5 bar with 0.6 bar maximum variation in set

Idle speed and CO specifications are given on the emissions decal in the vehicle engine compartment.

FUEL PUMP: min. 850 cc in 30 seconds

COLD CONTROL PRESSURE

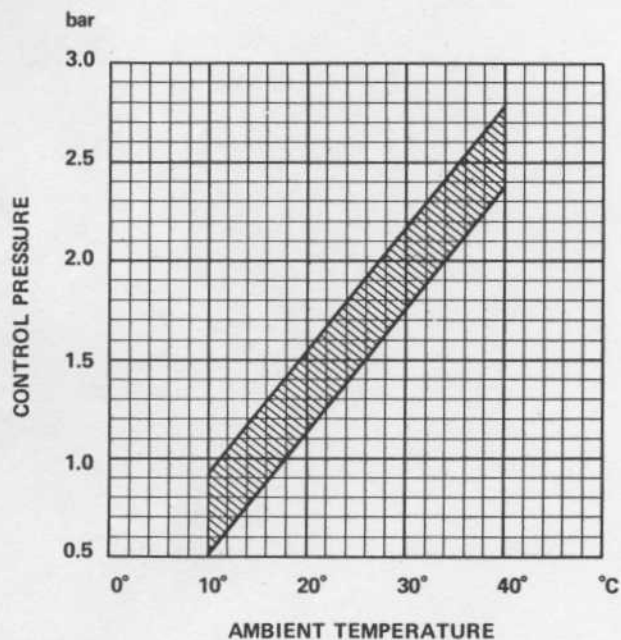

0 438 140 008

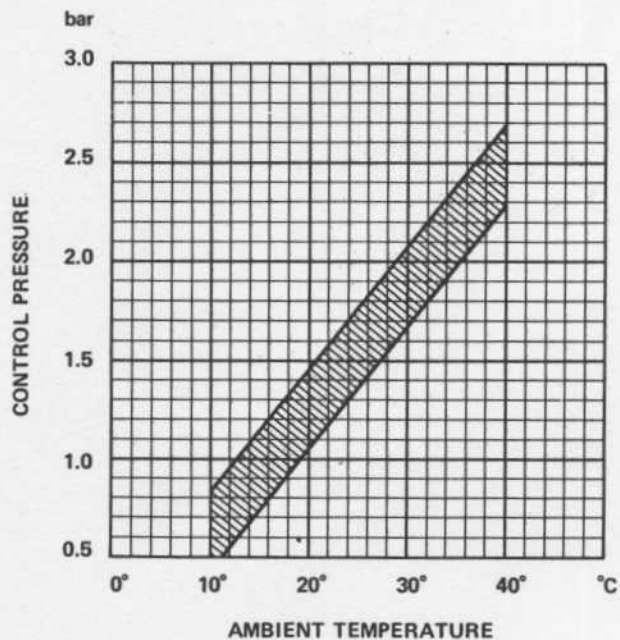

0 438 140 009

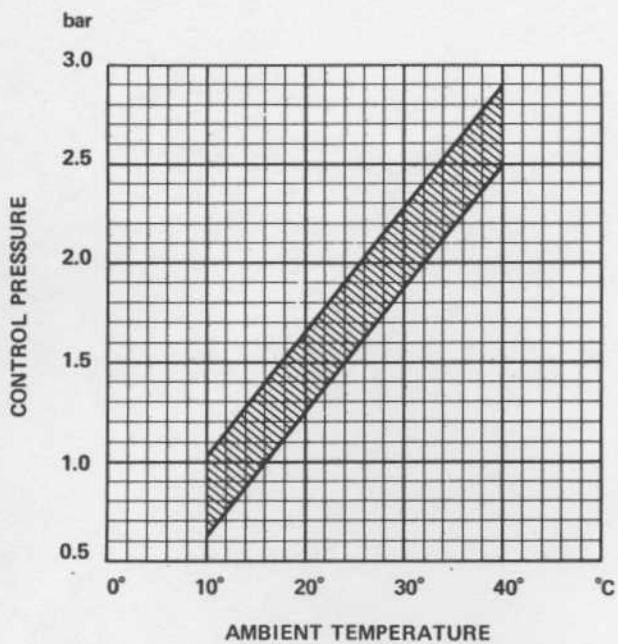

0 438 140 017
033

WARM CONTROL PRESSURE:

1974/75 model with throttle activated valve

Idle		
	checking value:	2.8 - 3.0 bar
	setting value:	2.85 - 2.95 bar
Part load:		3.4 - 3.8 bar
Full load:		2.6 - 3.0 bar

1974/75 model with vacuum enriched full load warm-up regulator

Without vacuum:	2.7 - 3.1 bar
With idle speed vacuum	3.4 - 3.8 bar

1976 model

Without vacuum:	2.7 - 3.1 bar
With engine vacuum at idle:	2.7 - 3.1 bar
With engine vacuum at 1800 RPM:	3.4 - 3.8 bar

1977 model

Without vacuum:	2.7 - 3.1 bar
With engine vacuum at idle:	3.4 - 3.8 bar

SYSTEM PRESSURE

Checking Value:	4.5 - 5.2 bar
Setting Value:	4.7 - 4.9 bar

LEAKAGE TEST

Minimum pressure after 10 minutes:	1.7 bar
Minimum pressure after 20 minutes:	1.5 bar

INJECTION VALVE OPENING PRESSURE: 2.5 - 3.6 bar

Idle speed and CO specifications are given on the emissions decal in the vehicle engine compartment.

FUEL PUMP: min. 1000 cc in 30 seconds

COLD CONTROL PRESSURE

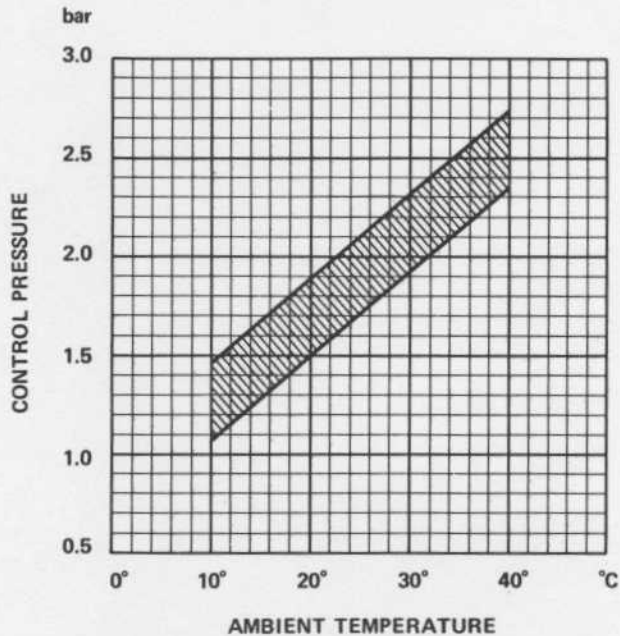

0 438 140 045

WARM CONTROL PRESSURE

Without vacuum: 2.7 - 3.1 bar
 With engine idle vacuum: 3.2 - 3.6 bar

SYSTEM PRESSURE

Checking Value: 4.5 - 5.2 bar
 Setting Value: 4.7 - 4.9 bar

LEAKAGE TEST

Minimum pressure after 10 minutes: 1.7 bar
 Minimum pressure after 20 minutes: 1.5 bar

INJECTION VALVE OPENING PRESSURE: 2.5 - 3.6 bar

Idle speed and CO specifications are given on the emissions decal in the vehicle engine compartment.

FUEL PUMP: min. 1360 cc in 30 seconds

COLD CONTROL PRESSURE

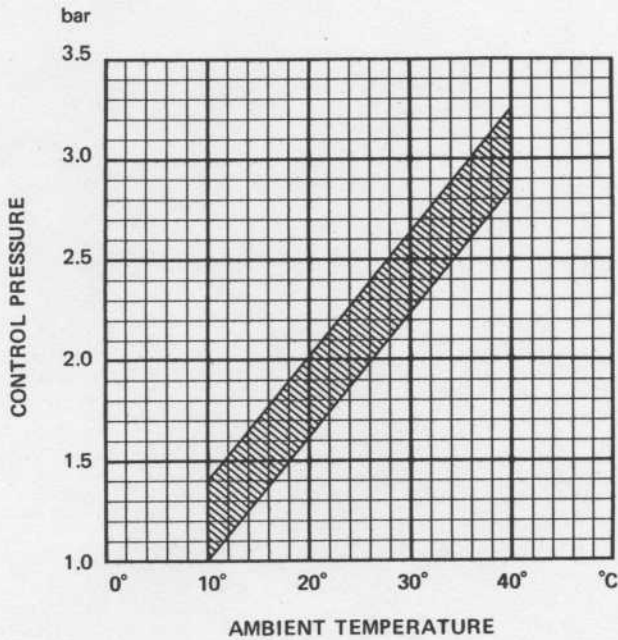

0 438 140 053

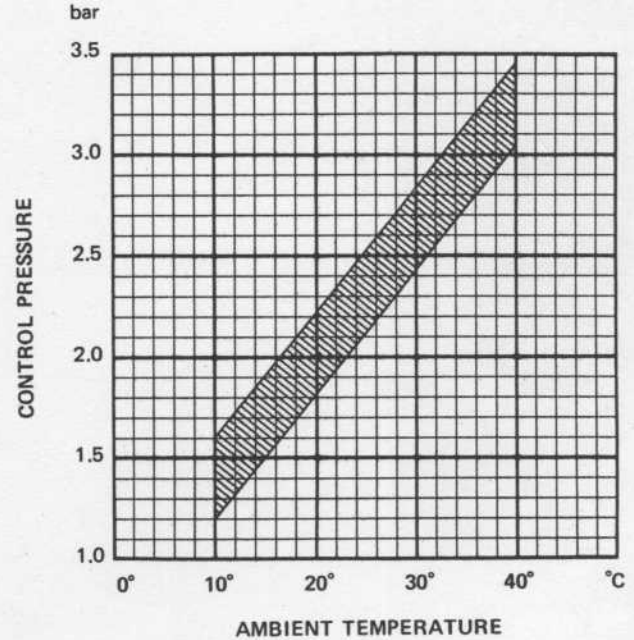

0 438 140 063

WARM CONTROL PRESSURE

0 438 140 053

Without vacuum: 2.8 - 3.2 bar
 With 390 - 450 mm Hg vacuum applied: 3.4 - 3.8 bar

0 438 140 063

Without vacuum: 2.8 - 3.2 bar
 With 340 - 420 mm Hg vacuum applied: 3.4 - 3.8 bar

SYSTEM PRESSURE

Checking Value: 5.2 - 5.8 bar
 Setting Value: 5.3 - 5.5 bar

LEAKAGE TEST

Minimum pressure after 10 minutes: 1.7 bar
 Minimum pressure after 20 minutes: 1.5 bar

INJECTION VALVE OPENING PRESSURE: 3.0 - 4.1 bar

Idle speed and CO specifications are given on the emissions decal in the vehicle engine compartment.

ROBERT BOSCH SALES CORPORATION  **ROBERT BOSCH**

Member of the Bosch Group

2800 South 25th Avenue, Broadview, Illinois 60153

Telephone: (312) 865-5200

JETRONIC SERVICE MANUAL
1979 Supplement

K-Jetronic

This packet contains the main title page, equipment lists and warranty information for the "K" volume of your Jetronic Service Manual. Use the main **contents** page on the back of the main title page to correctly place all information in the manual. When a new page replaces an old page, the new page will have a revision date (12/79) at the bottom of the page. Always keep the page with the latest revision. The older page should be discarded, as it may contain information which is no longer valid. New pages which do not replace old pages are simply inserted at the appropriate place in each volume.

ROBERT BOSCH SALES CORPORATION
Automotive Service Department

Packet: J-793

Headquarters: Broadview, Illinois—AIRMAIL: P.O. Box 66008, A.M.F., O'Hare, IL 60666

Cable: ROBOSPARK, BROADVIEWILLINOIS • TELEX: 72-8466

Regional Offices: Paramus, New Jersey • Atlanta • San Francisco • Los Angeles

 and **ROBERT BOSCH** are trademarks of Robert Bosch GmbH, Stuttgart, Germany

ROBERT BOSCH

K-JETRONIC SERVICE MANUAL

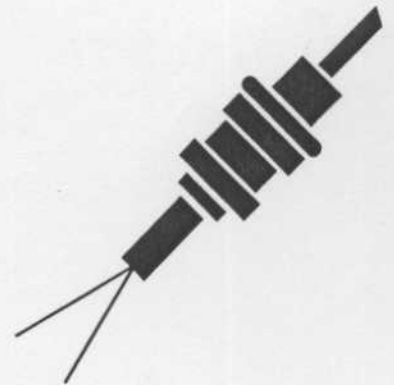

2800 SOUTH 25TH AVENUE, BROADVIEW, ILLINOIS 60153 • 60 BAYLIS ROAD, MELVILLE, NEW YORK 11746 • 345 EAST GRAND AVENUE, SOUTH SAN FRANCISCO, CALIFORNIA 94080 • 4131-A DIRECTORS ROW, HOUSTON, TEXAS 77018 • 6300 ARIZONA CIRCLE, LOS ANGELES, CALIFORNIA 90045 • 20100 CIVIC CENTER DRIVE, SUITE 316, SOUTHFIELD, MICHIGAN 48076

CONTENTS

K-Jetronic Pictorial

General Information

Limited Warranty Policy

Warranty Procedure

Manufacturing Dates

Conversion to Metric Units

Metric Conversion Chart

Equipment Lists

Workshop Manuals

Audi

BMW

Mercedes-Benz

Porsche

Saab

Volkswagen

Volvo

Service Bulletins

EQUIPMENT LISTS

K-Jetronic

ROBERT BOSCH

AUDI K-Jetronic Equipment

MODEL	YEAR	MIXTURE CONTROL UNIT 0 438 040...	FUEL DISTRIBUTOR 0 438 100...	AIR FLOW SENSOR 0 438 120...	INJECTION VALVE 0 437 502...
100	1975	005	005	007	008
	1976	005	005	007	008
	1977	005	005	007	008
FOX	1975	006	007	008	007
	1976	006	007	008	007
	1977	020	021	033	007
	1978	035	030	054	015
	1979	035	061	054	015
FOX CAL	1978	052	043	088	015
	1979	065	058	105	015
5000	1978	0 438 050 001	024	040	015
	1979	0 438 050 001	060	040	015
5000 CAL	1979	0 438 050 005	062	052	015

Fox models use vacuum limiter 0 280 160 116 (MT) or 0 280 162 104 (HA, MT)

5000 models use vacuum limiter 0 280 160 126 (MT)

MT – Manual Transmission
 AT – Automatic Transmission
 HA – High Altitude
 CAL – California models

12/79

K-Jetronic Equipment **AUDI**

FUEL PUMP 0 580 254...	FILTER 0 450 905...	FUEL ACCUMULATOR 0 438 170...	WARM-UP REGULATOR 0 438 140...	AUXILIARY AIR VALVE 0 280 140...	COLD START VALVE 0 280 170...	THERMO-TIME SWITCH 0 280 130...
992	011	007	011	100	406	214
992	011	007	011	100	406	214
980	011	007	011	100	406	214
992	003	007	011	107	401	214
992	003	007	011	107	401	214
980	003	007	011	107	402	214
980	025	019	011 026 (HA)	107	402	214
980	025	019	011	107	402	214
980	025	019	011 026 (HA)	107	402	214
980	028	019	048	107	402	214
980	025	019	034	104	400	214
970	025	019	034	104	400	214
970	028	019	048	100 (AT) 104 (MT)	400	214

LAMBDA COMPONENTS

	Lambda Sensor 0 258 001...	Frequency Valve 0 280 150...	Control Unit 0 280 800...
Fox CAL 1979	013	300	011
5000 CAL 1979	013	300	007 (AT) 009 (MT)

BMW K-Jetronic Equipment

MODEL	YEAR	MIXTURE CONTROL UNIT 0 438 040...	FUEL DISTRIBUTOR 0 438 100...	AIR FLOW SENSOR 0 438 120...	INJECTION VALVE 0 437 502...
320i	1977	019	023	030	007
	1978	019	023	030	007
	1979	019	023	030	007
320i CAL	1977	027	023	039	007
	1978	027	023	039	007
	1979	027	023	039	007

320i models use:

Vacuum Limiter 0 280 160 305 (CAL)
0 280 162 102 (HA)

Electro Air Valve 0 280 160 402

Fuel Pump Relay 0 332 204 401

CAL - California models
HA - High Altitude

K-Jetronic Equipment **BMW**

FUEL PUMP 0 580 254...	FILTER 0 450 905...	FUEL ACCUMULATOR 0 438 170...	WARM-UP REGULATOR 0 438 140...	AUXILIARY AIR VALVE 0 280 140...	COLD START VALVE 0 280 170...	THERMO-TIME SWITCH 0 280 130...
982	—	007	014	104	405	214
982	—	007	014	104	405	214
982	—	007	014	104	405	214
982	—	007	014	0280 160 402	405	214
982	—	007	014	0280 160 402	405	214
982	—	007	014	0280 160 402	405	214

MERCEDES-BENZ K-Jetronic Equipment

MODEL	YEAR	MIXTURE CONTROL UNIT 0 438 040...	FUEL DISTRIBUTOR 0 438 100...	AIR FLOW SENSOR 0 438 120...	INJECTION VALVE 0 437 502...
280 E, SE, CE	1977	0 438 060 014	011	032	010
	1978	0 438 060 014	011	032	010
	1979	0 438 060 014	011	032	010
450 SL, SLC 450 SEL, SE	1976	003	012	062	010
	1977	003	012	062	010
	1978	003	012	062	010
	1979	003	012	062	010
6.9	1977	003	012	062	010
	1978	003	012	062	010
	1979	003	012	062	010

All models use **diaphragm damper** 0 280 161 007

CAL – California models

HA – High Altitude

K-Jetronic Equipment **MERCEDES-BENZ**

FUEL PUMP 0 580 254...	FILTER 0 450 905...	FUEL ACCUMULATOR 0 438 170...	WARM-UP REGULATOR 0 438 140...	AUXILIARY AIR VALVE 0 280 140...	COLD START VALVE 0 280 170...	THERMO-TIME SWITCH 0 280 130...
984	004	004	030 031 (CAL)	037	403	—
975	004	004	030 031 (CAL) 041 (HA)	037	403	—
975	004	004	030 031 (CAL) 041 (HA)	037	403	—
984	004	004	015	032	403	—
975	004	004	015 043 (HA)	032	403	—
975	004	004	015 043 (HA)	032	403	—
975	004	004	061	032	403	—
984	004	004	010	032	403	—
975	004	004	010 042 (HA)	032	403	—
975	004	004	060	032	403	—

PORSCHE K-Jetronic Equipment

MODEL	YEAR	MIXTURE CONTROL UNIT 0 438 040...	FUEL DISTRIBUTOR 0 438 100...	AIR FLOW SENSOR 0 438 120...	INJECTION VALVE 0 437 502...
911 T	1973	001	017	002	002
911, 911 S	1974	003	017	004	004
	1975	005	006	004	004
	1976	005	006	004	004
	1977	005	006	004	004
911 SC	1978	018	031	070	004
	1979	018	031	070	004
Turbo	1976	011	016	024	009
	1977	011	016	024	009
	1978	022	037	085	009
	1979	022	037	085	009
924	1976	0 438 040 012	005	022	013
	1977	0 438 040 047	039	066	013
	1978	0 438 040 047	039	066	013
	1979	0 438 040 063	005	103	013
928	1978	0 438 080 004	027	049	012
	1979	0 438 080 009	027	107	012

AC - air conditioning
1 - from 9/77 thru 2/78
2 - from 3/78 thru 8/78

911T 1973

Throttle Valve 0 438 160 001
Vacuum Limiter 0 280 160 102

911 SC 1977 on

Vacuum Limiter 0 280 160 111
Electro Air Valve 0 280 160 400

911 1974
1974 - 77

Throttle Valve 0 438 160 001
Vacuum Limiter 0 280 160 111

12/79

K-Jetronic Equipment **PORSCHE**

FUEL PUMP 0 580 254...	FILTER 0 450 905...	FUEL ACCUMULATOR 0 438 170...	WARM-UP REGULATOR 0 438 140...	AUXILIARY AIR VALVE 0 280 140...	COLD START VALVE 0 280 170...	THERMO-TIME SWITCH 0 280 130...
---------------------------	------------------------	----------------------------------	-----------------------------------	-------------------------------------	----------------------------------	------------------------------------

998	0 450 903 007	015	008	—	025	—
998	007	015	008	—	102	—
991	033	015	009	—	402	—
985	003	015	017	200	402	—
985	016	009	033	206	402	—
984	021	009	045	209	409	—
984	021	009	045	209	409	—
990	009	005	022	205	401	—
990	009	005	022	205	401	—
984 and 979	009	005	054	212	400	—
984 and 979	009	005	054	214	400	—
976	003	015	011	100	401	214
976	021	015	011	100	401	223
976	021	015	011	100	401	223
984	021	024	011	100	401	223
984 and 979	019 ¹ 024 ²	018 ¹ 022 ²	053 023(HA)	211	402	214
984 and 979	—	025	063	211	402	214

Turbo	1976 on	Vacuum Limiter Electro Air Valve	0 280 160 302 0 280 160 404	928	1978 on	Electro Air Valve (AC) Vacuum Limiter Control Capsule	0 280 141 001 0 280 162 200 0 280 162 009
924	1976 on 1979 on	Vacuum Limiter Solenoid Valve	0 280 160 124 0 280 170 500				

12/79

SAAB K-Jetronic Equipment

MODEL	YEAR	MIXTURE CONTROL UNIT 0 438 040...	FUEL DISTRIBUTOR 0 438 100...	AIR FLOW SENSOR 0 438 120...	INJECTION VALVE 0 437 502...
99 GL, GLE 99 EMS	1975	007	005	009	004
	1976	007	005	009	004
	1977	⁰³⁴ 007 (AT)	005	⁰⁴⁶ 009 (AT)	004
	1978	049	023	071	004
	1979	049	023	071	004
99 GL, GLE 99 EMS CAL	1977	028	018	050	004
	1978	051	032	073	004
	1979	051	032	073	004
99 Turbo	1978	051	032	073	004
900	1979	049	023	071	004
900 CAL	1979	051	032	073	004
900 Turbo	1979	051	032	073	004

1976 and 1977 99 Series use fuel pump relay 0 332 204 125

AT - Automatic Transmission
CAL - California models

K-Jetronic Equipment **SAAB**

FUEL PUMP 0 580 254...	FILTER 0 450 905...	FUEL ACCUMULATOR 0 438 170...	WARM-UP REGULATOR 0 438 140...	AUXILIARY AIR VALVE 0 280 140...	COLD START VALVE 0 280 170...	THERMO-TIME SWITCH 0 280 130...
994	005	001	013	107	401	214
994	005	001	013	107	401	217
994	005	001	020	107	401	217
978	021	014	020	107	401	217
985	021	010	020	107	401	217
994	005	001	032	107	401	217
978	021	014	032	107	401	217
978	021	010	032	107	401	217
978	021	014	051	107	401	217
978	021	010	020	107	401	217
978	021	010	032	107	401	217
978	021	010	051	107	401	217

LAMBDA COMPONENTS

		Lambda Sensor 0 258 001...	Frequency Valve 0 280 150...	Control Unit 0 280 800...
99 CAL	1977	001	300	002
	1978	001	300	002
	1979	012	300	002
99 Turbo	1978	001	300	004
900 CAL	1979	012	300	002
900 Turbo	1979	012	300	004

VOLKSWAGEN K-Jetronic Equipment

MODEL	YEAR	MIXTURE CONTROL UNIT 0 438 040...	FUEL DISTRIBUTOR 0 438 100...	AIR FLOW SENSOR 0 438 120...	INJECTION VALVE 0 437 502...
Dasher	1975	006	007	008	007
	1976	006	007	008	007
	1977	020	021	033	007
	1978	035 052	030 043 (CAL)	054 088 (CAL)	015
	1979	035	061	054	015
Rabbit, Scirocco	1977	025	007	033	007
	1978	020	021	033	015
	1979	035	061	054	015

All Dasher models with manual transmission use **vacuum limiter** 0 280 160 116

Rabbit and Scirocco models with manual transmission use **vacuum limiter** 0 280 160 122 or 0 280 162 106 (HA)

K-Jetronic Equipment **VOLKSWAGEN**

FUEL PUMP 0 580 254...	FILTER 0 450 905...	FUEL ACCUMULATOR 0 438 170...	WARM-UP REGULATOR 0 438 140...	AUXILIARY AIR VALVE 0 280 140...	COLD START VALVE 0 280 170...	THERMO-TIME SWITCH 0 280 130...
992	003	001	011	107	401	214
992	003	001	011 026 (HA)	107	401	214
980	003	007	011 026 (HA)	107	402	214
980	025	019	011	107	402	214
980	025	019	011	107	402	214
980	014	007	011	107	402	214
980	021	019	011 026 (HA)	107	402	214
980	021	019	011	107	402	214

VOLVO K-Jetronic Equipment

MODEL	YEAR	MIXTURE CONTROL UNIT 0 438 040...	FUEL DISTRIBUTOR 0 438 100...	AIR FLOW SENSOR 0 438 120...	INJECTION VALVE 0 437 502...
142/144/145	1974	004	005*	013	003
	1975	004	005	013	003
242/244/245	1976	003	005	005	007
	1977	003	005	005	007
	1978	055	023	077	007
	1979	055	023	077	015
242/244/245 CAL	1977	014	018	025	007
	1978	044	032	078	007
	1979	044	032	078	015
262/264/265	1976	0 438 060 008	006	016	005
	1977	0 438 060 008	006	016	005
	1978	0 438 060 026 0 438 060 019	035 033 (CAL)	080 056 (CAL)	005
	1979	0 438 060 019	033	056	013

*Accessory kit 2 437 001 001 is required to install new fuel distributor 0 438 100 005 in 1974 Volvo.

LAMBDA COMPONENTS

		Lambda Sensor 0 258 001 ...	Frequency Valve 0 280 150 ...	Control Unit 0 280 800 ...
240 Series	1977 CAL	001	300	001
	1978 CAL	004	300	001
	1979	004	300	001
260 Series	1978 CAL	005	300	003
	1979	005	300	005

HA - High Altitude
AT - Automatic Transmission
CAL - California Models

12/79

K-Jetronic Equipment **VOLVO**

FUEL PUMP 0 580 254...	FILTER 0 450 905...	FUEL ACCUMULATOR 0 438 170...	WARM-UP REGULATOR 0 438 140...	AUXILIARY AIR VALVE 0 280 140...	COLD START VALVE 0 280 170...	THERMO-TIME SWITCH 0 280 130...
996	001	001	004	100	100	—
996	006	001	014	106	404	—
996	010	001	014	106	404	—
996	010	007	004 021 (HA)	100	404	—
996	010	007	004	100	404	—
996	021	007	004	106 114 (AT)	404	—
996	010	007	004	100	404	—
996	010	007	004	100	404	—
996	021	007	004	106 114 (AT)	404	—
996	010	001	018	202	400	—
996	010	007	029 021 (HA)	202	400	—
996	010	014	029 021 (CAL)	202	400	—
996	021	021	004	202	400	—

FUEL PUMP RELAY

240	1975, 1976, 1977 1978	0 332 204 125 0 332 015 009 and 0 332 204 110
240 CAL	1976, 1977 1978	0 332 204 125 0 332 015 001, 0 332 015 009 and 0 332 204 110
260	1976, 1977 1978	0 332 204 125 0 332 015 009 and 0 332 204 110
260 CAL	1978	0 332 015 001 0 332 015 009 and 0 332 204 110